

VIRTUAL COMMUNITY WORKSHOP

Changing your Zoom Background
and Using Video Filters

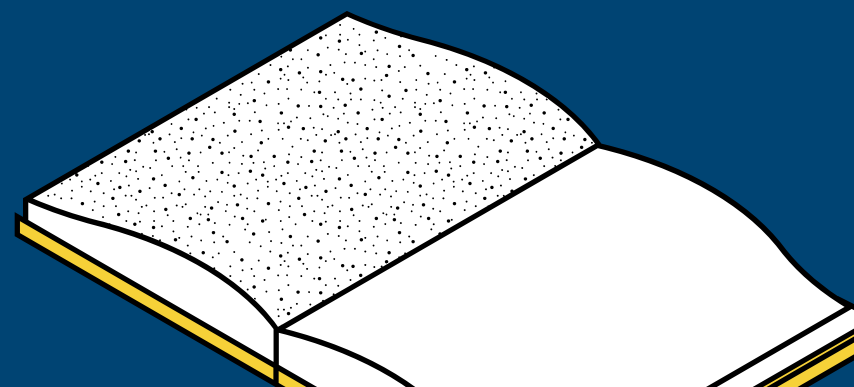

WELCOME TO THE WORKSHOP!

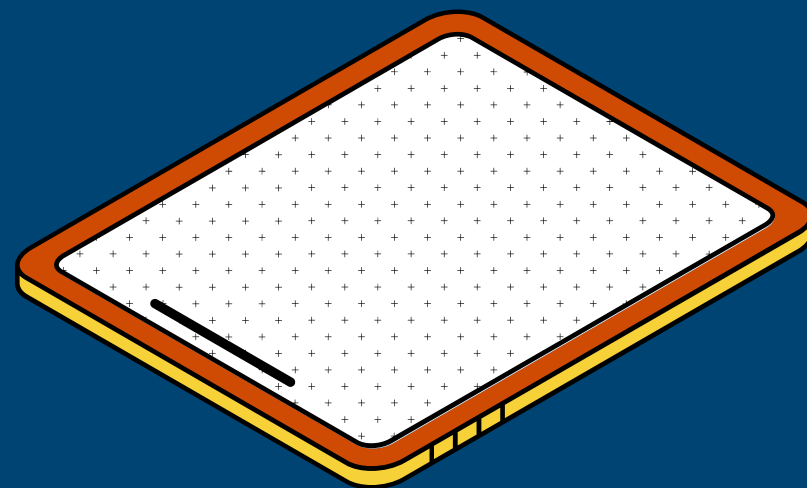
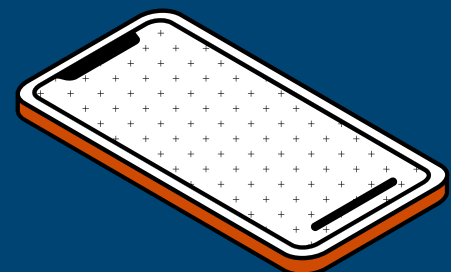
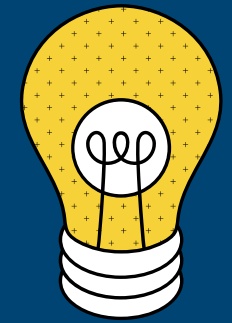
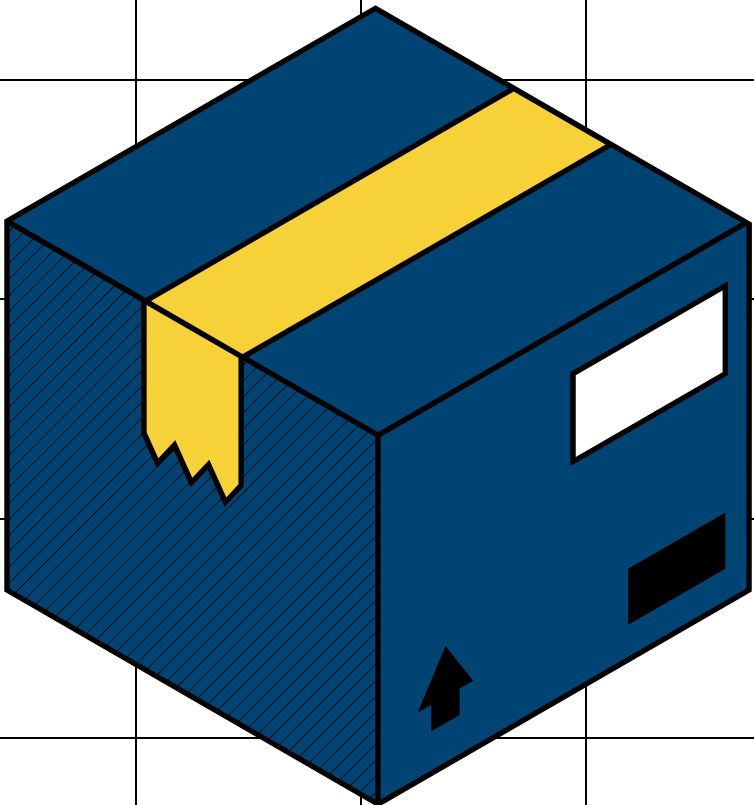
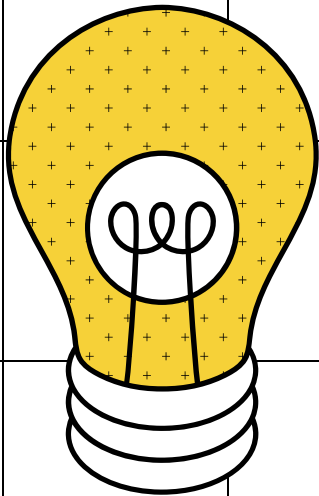
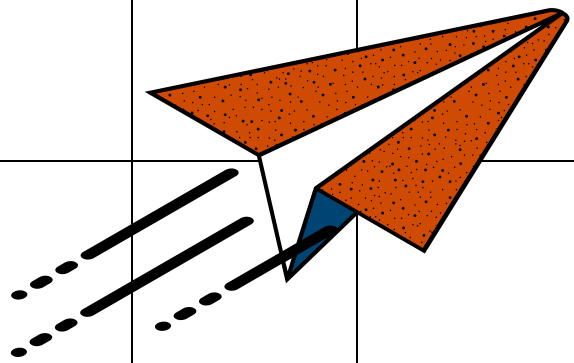

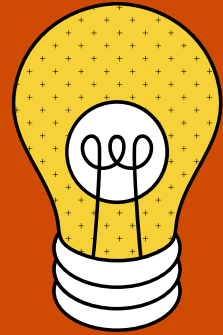

LEARNING GOALS

How to change your virtual background image

- using a desktop
- using an iPad
- using a mobile device

How to add video filters

- using a desktop
- using an iPad
- using a mobile device

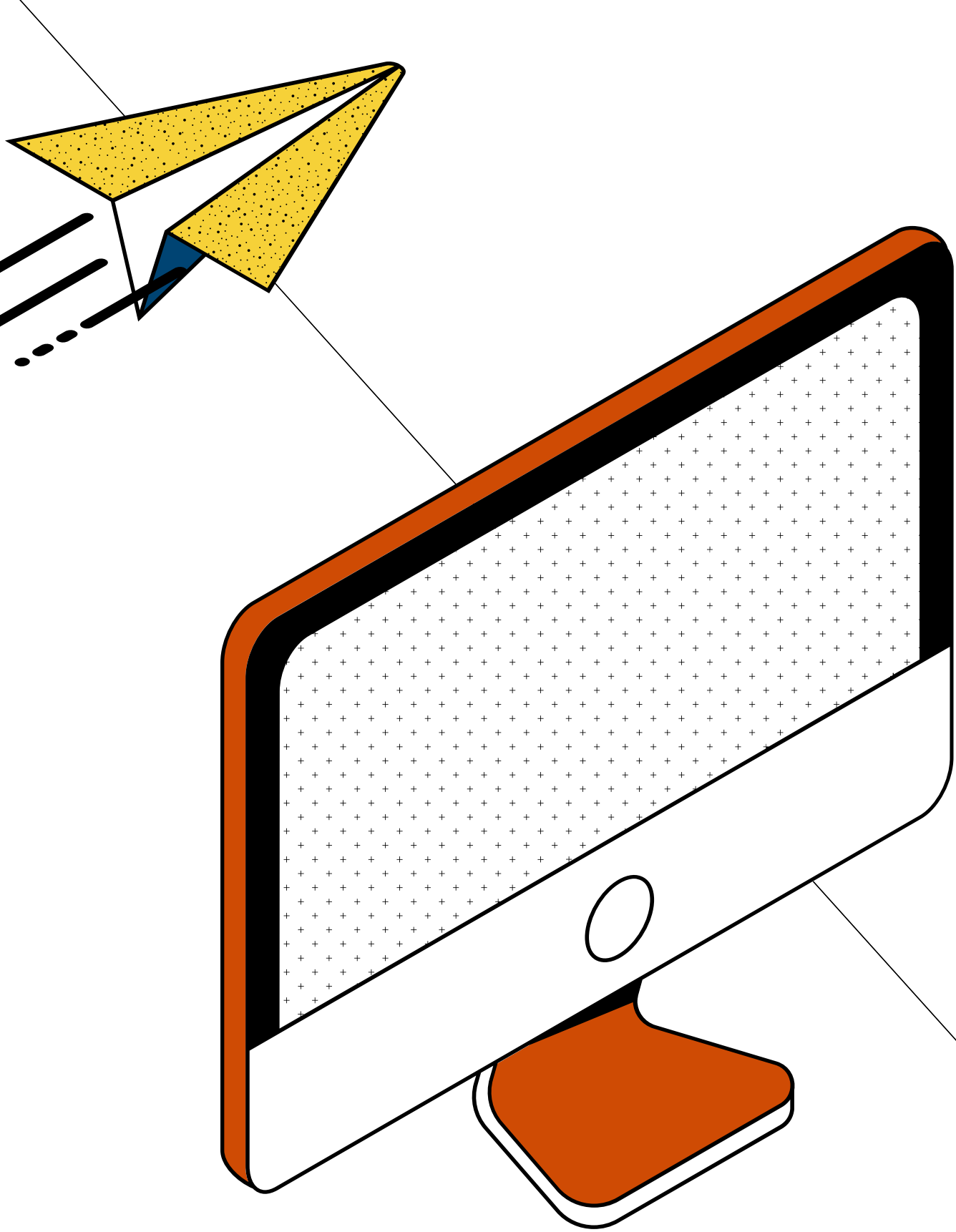

WHY BOTHER WITH BACKGROUNDS AND FILTERS?

Changing your background image can help block out distractions.

Video filters can also be a fun way to personalize your Zoom experience.

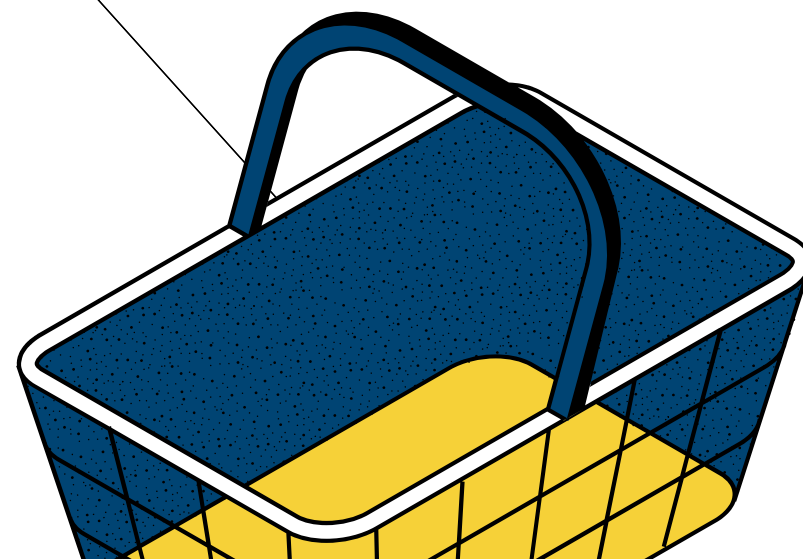

CHANGING YOUR VIRTUAL BACKGROUND ON DESKTOP



STEP 1

Sign in to Zoom

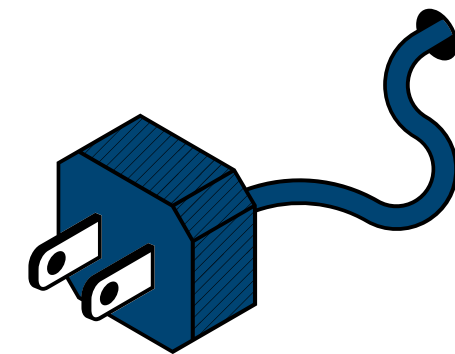

STEP 1

Sign in to Zoom

STEP 2

Click on your profile picture located on in the top right of your window

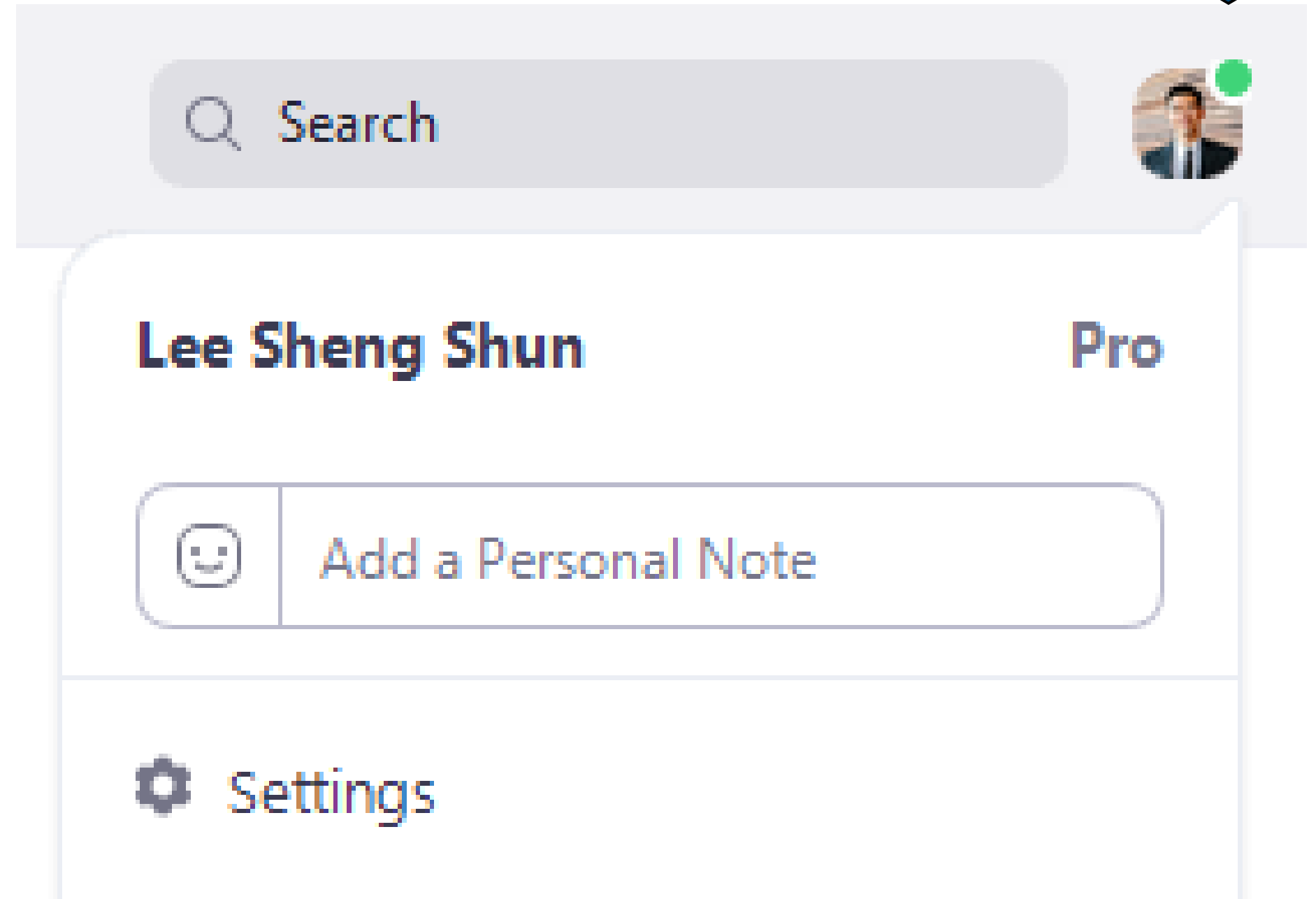
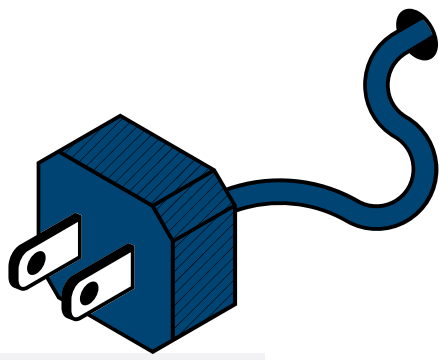

STEP 1

Sign in to Zoom

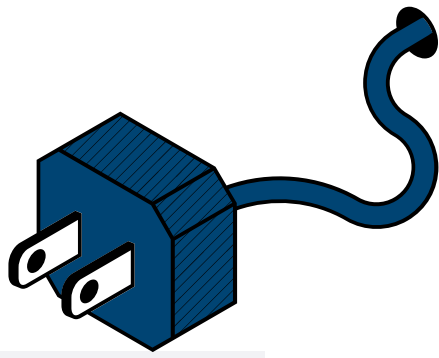

STEP 2

Click on your profile picture located on in the top right of your window

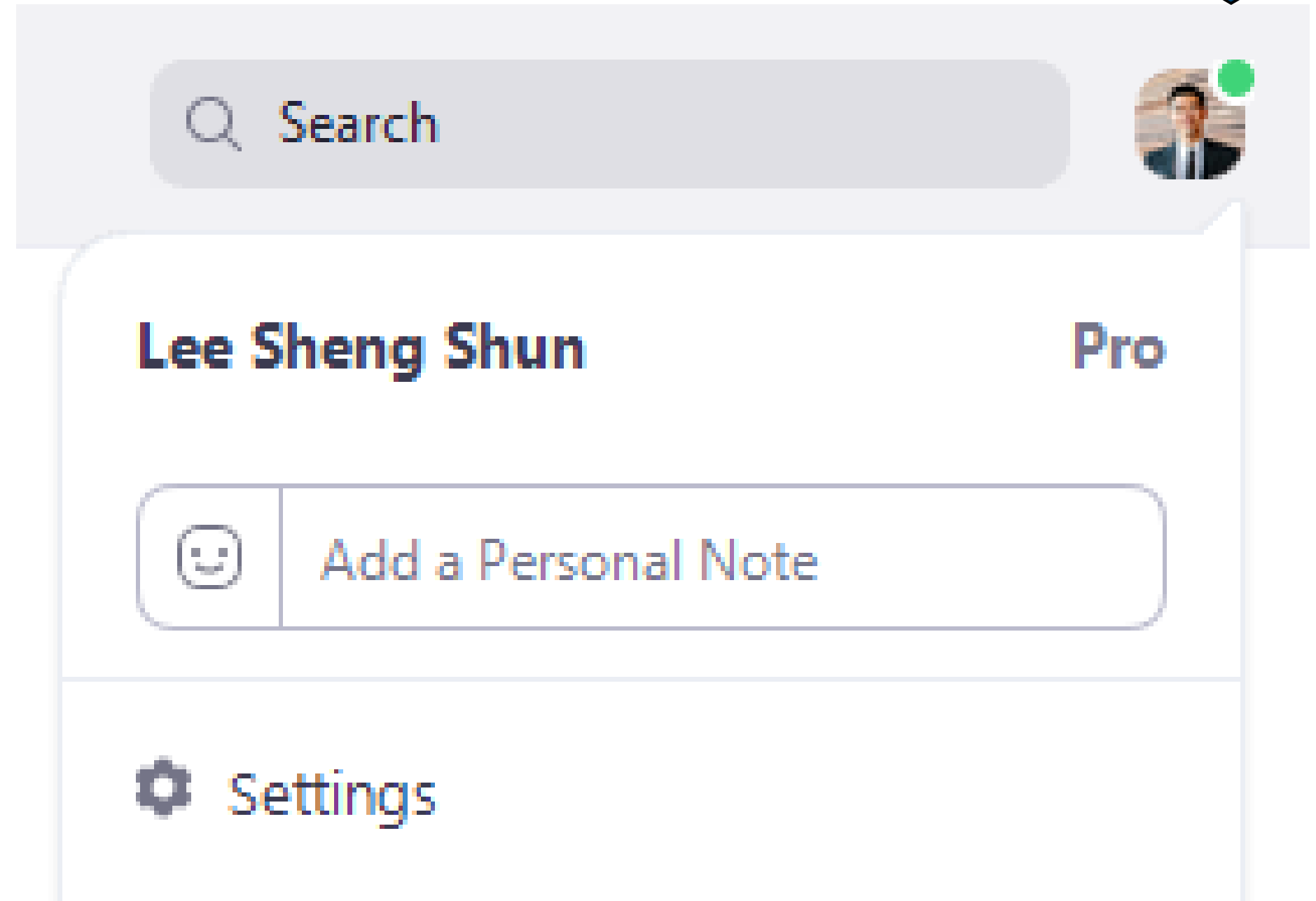

STEP 3

In the drop down menu, click "



settings"

STEP 4

Select "  Background & Filters "

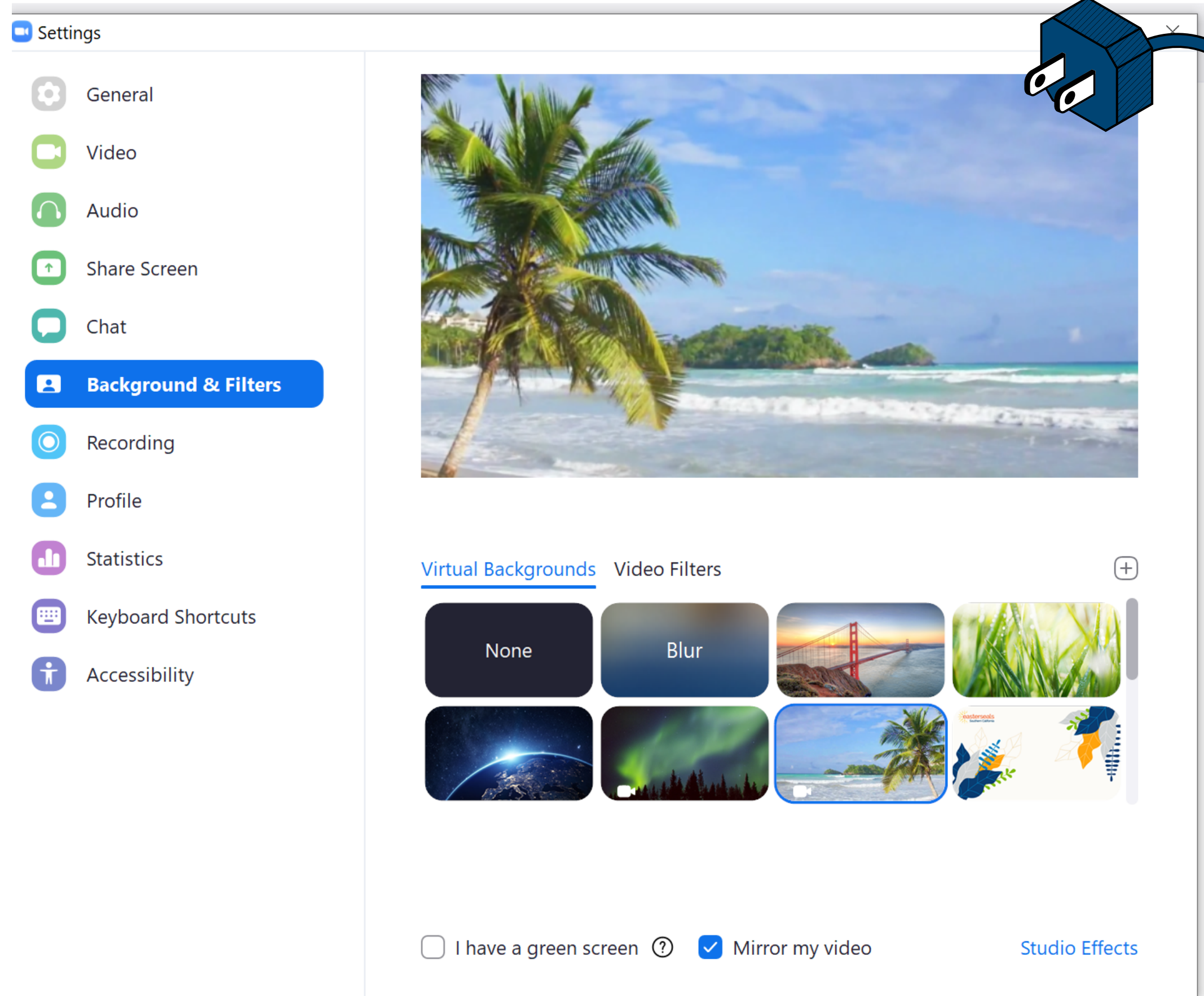

Settings

- General
- Video
- Audio
- Share Screen
- Chat
- Background & Filters**
- Recording
- Profile
- Statistics
- Keyboard Shortcuts
- Accessibility

Virtual Backgrounds Video Filters

None Blur

I have a green screen Mirror my video [Studio Effects](#)

STEP 4

Select "  Background & Filters "

STEP 5

Click on an image or video to select your desired virtual background

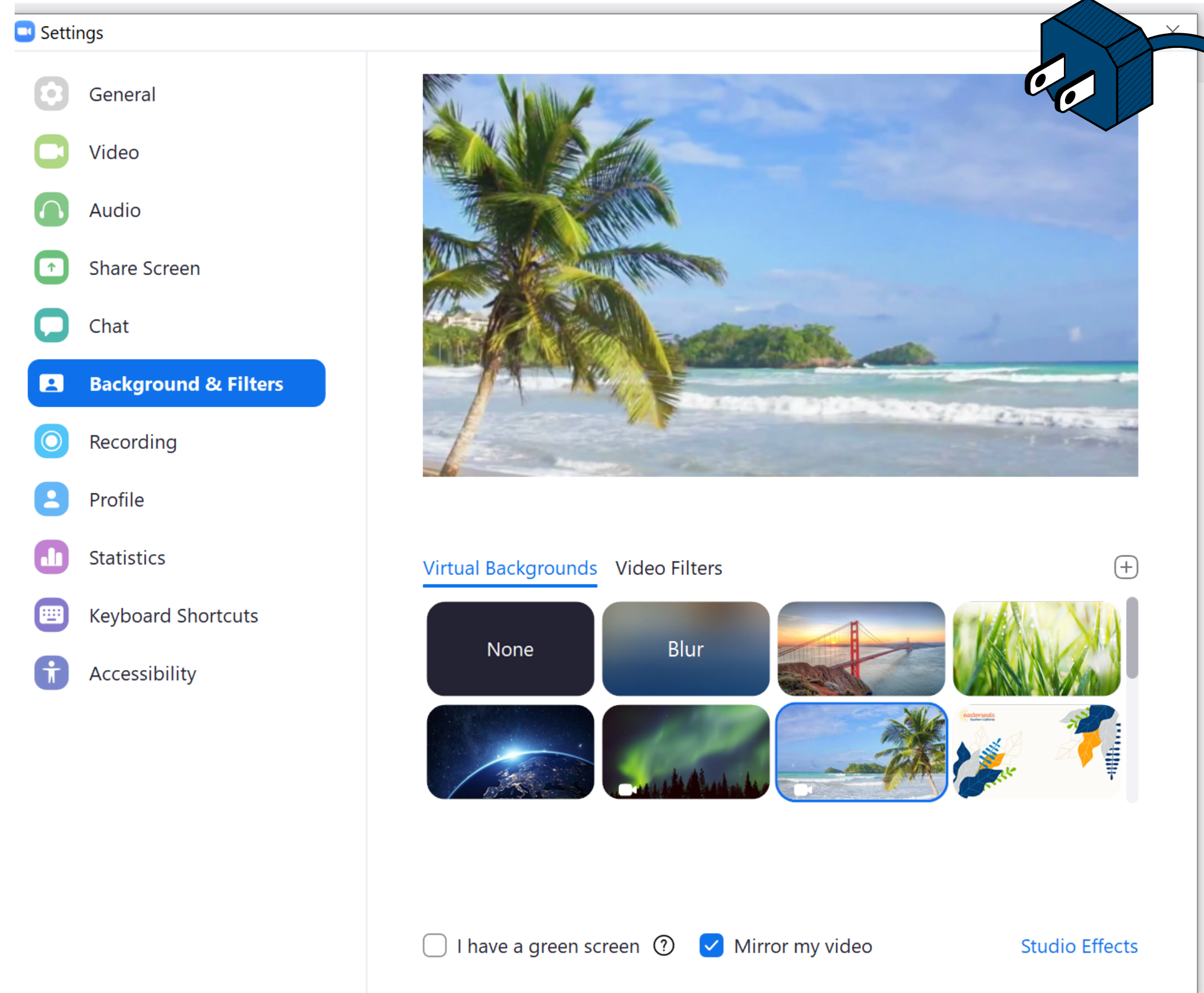

The screenshot shows the Zoom Settings window with the 'Background & Filters' tab selected. The main preview area displays a tropical beach background with a palm tree. Below the preview, there are two sections: 'Virtual Backgrounds' and 'Video Filters'. The 'Virtual Backgrounds' section includes options for 'None', 'Blur', and several image-based backgrounds like the Golden Gate Bridge, grass, Earth from space, aurora borealis, and another tropical beach. The 'Video Filters' section shows a grid of filter thumbnails. At the bottom, there are checkboxes for 'I have a green screen' (unchecked) and 'Mirror my video' (checked), along with a 'Studio Effects' link. A blue power plug icon is overlaid in the top right corner of the window.

Settings

- General
- Video
- Audio
- Share Screen
- Chat
- Background & Filters**
- Recording
- Profile
- Statistics
- Keyboard Shortcuts
- Accessibility

Virtual Backgrounds Video Filters

None Blur

I have a green screen Mirror my video [Studio Effects](#)

CHANGING YOUR VIRTUAL BACKGROUND ON DESKTOP

while in a meeting



STEP 1

While in a meeting,
click on the small
arrow next to the
camera icon

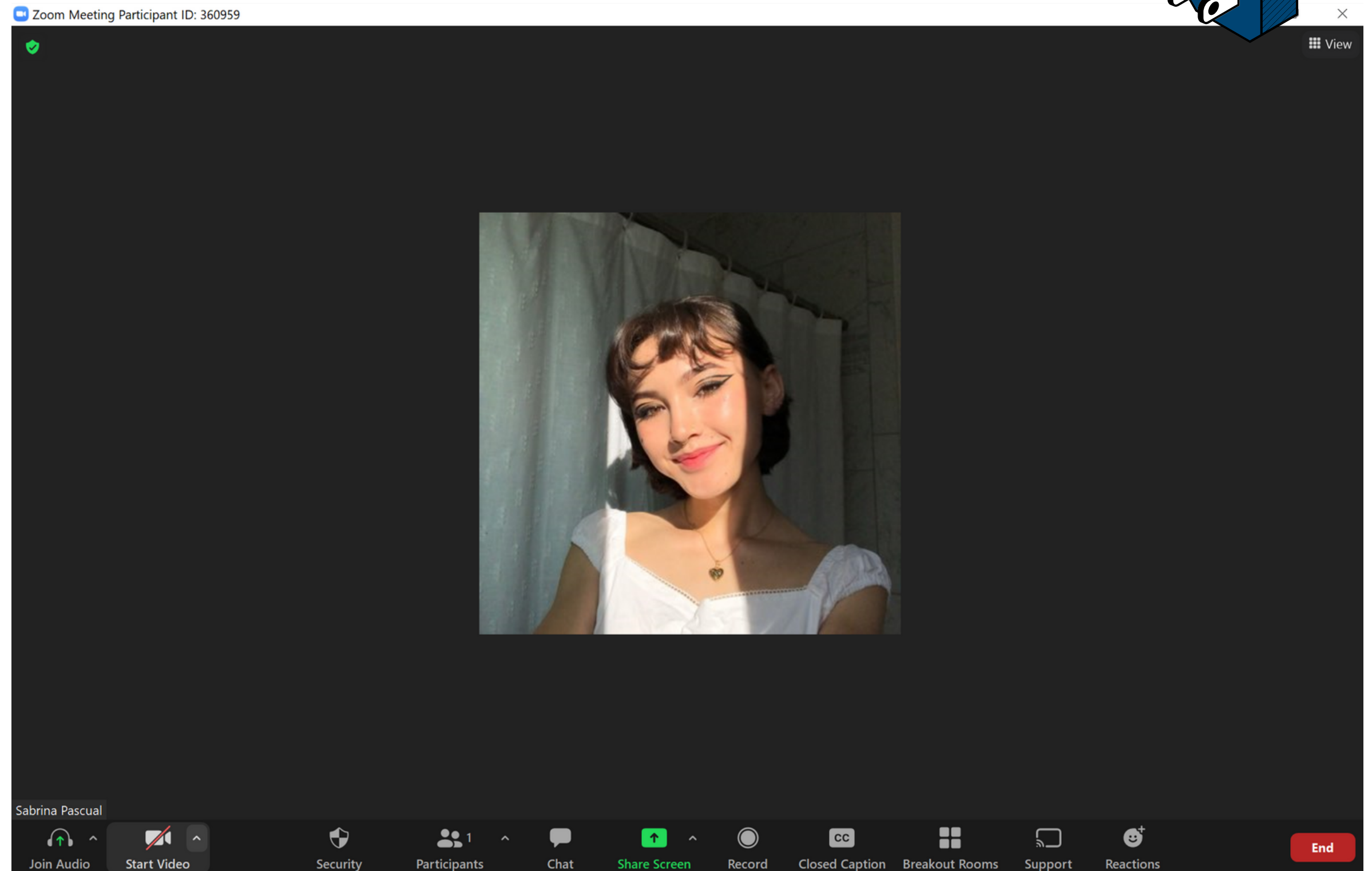
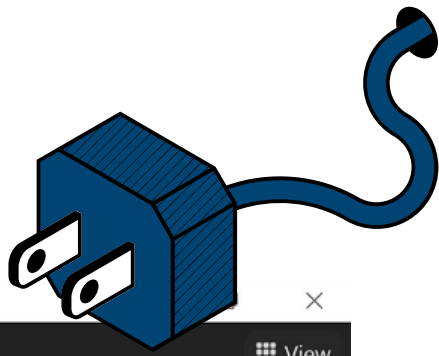

STEP 2

Click on " Choose
Virtual Background... "

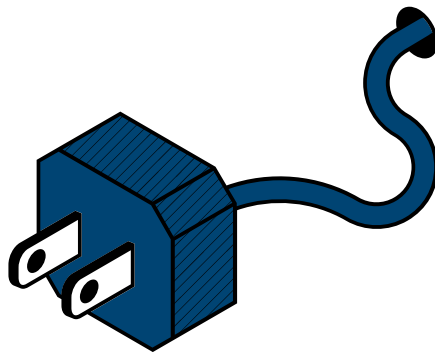

A screenshot of a video meeting interface. The main area is dark with a video feed on the right showing a person's arm. A menu is open over the video feed with the following options: 'Select a Camera' (with a checkmark next to 'Surface Camera Front'), 'Choose Virtual Background...' (highlighted in blue), 'Choose Video Filter...', and 'Video Settings...'. At the bottom, there is a control bar with icons for 'Join Audio', 'Start Video' (with a red slash), 'Security', 'Participants' (with a '1' next to it), 'Chat', and 'Share'. The name 'Sabrina Pascual' is visible in the bottom left corner of the video area.

STEP 3

Select "  Background & Filters "

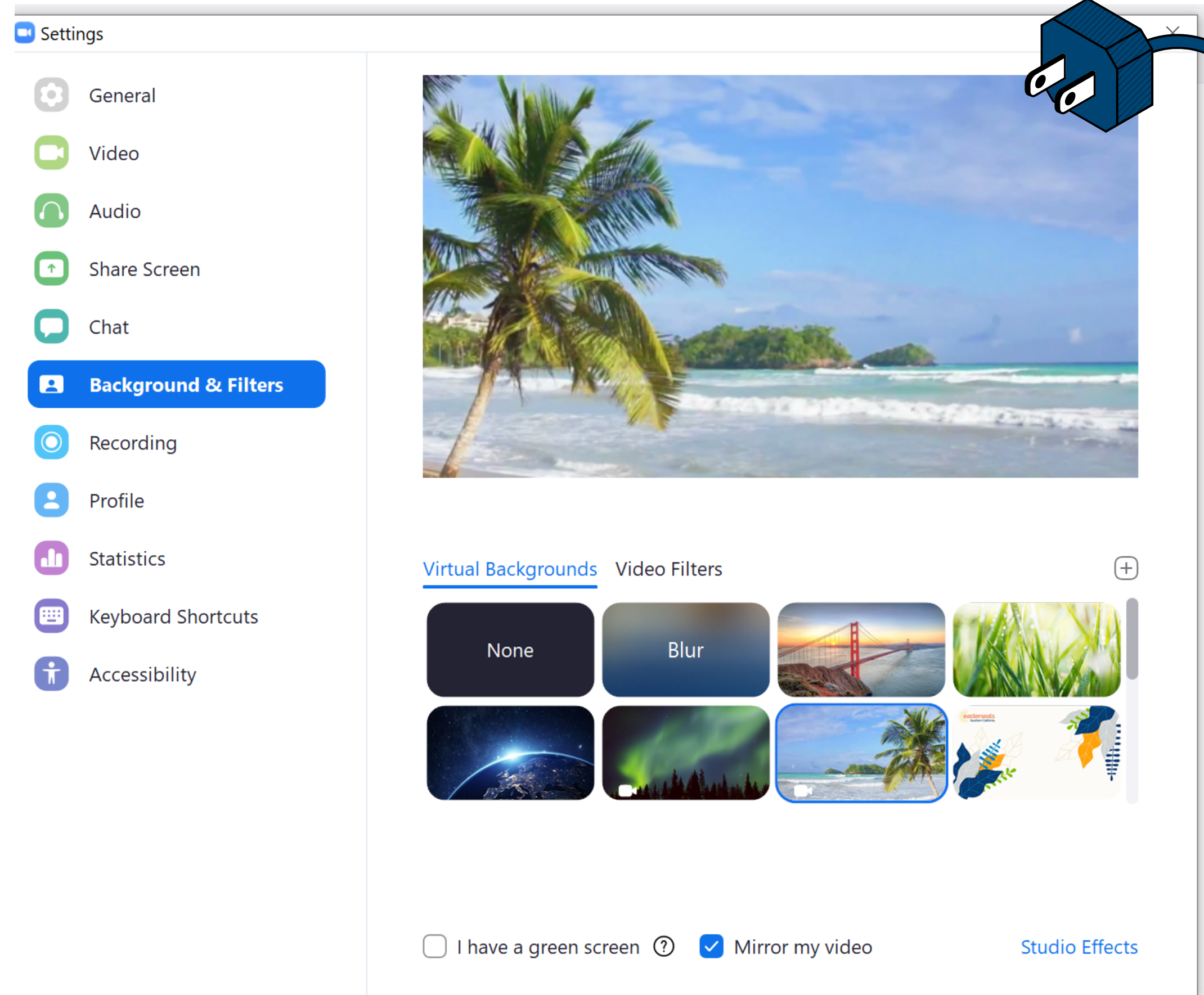

The screenshot shows the Zoom Settings application window. The title bar reads "Settings". On the left is a sidebar menu with the following items: General, Video, Audio, Share Screen, Chat, **Background & Filters** (highlighted in blue), Recording, Profile, Statistics, Keyboard Shortcuts, and Accessibility. The main content area is titled "Background & Filters" and features a large preview window at the top showing a tropical beach scene with a palm tree. Below the preview are two tabs: "Virtual Backgrounds" (selected) and "Video Filters". Under "Virtual Backgrounds", there are several thumbnails: "None", "Blur", a Golden Gate Bridge scene, a grass scene, a night Earth scene, an aurora scene, a palm tree scene, and a "Webinars" logo. At the bottom of the settings page, there are two checkboxes: "I have a green screen" (unchecked) and "Mirror my video" (checked). A "Studio Effects" link is located in the bottom right corner. A blue power plug icon is overlaid in the top right corner of the window.

STEP 3

Select "  Background & Filters "

STEP 4

Click on an image or video to select your desired virtual background

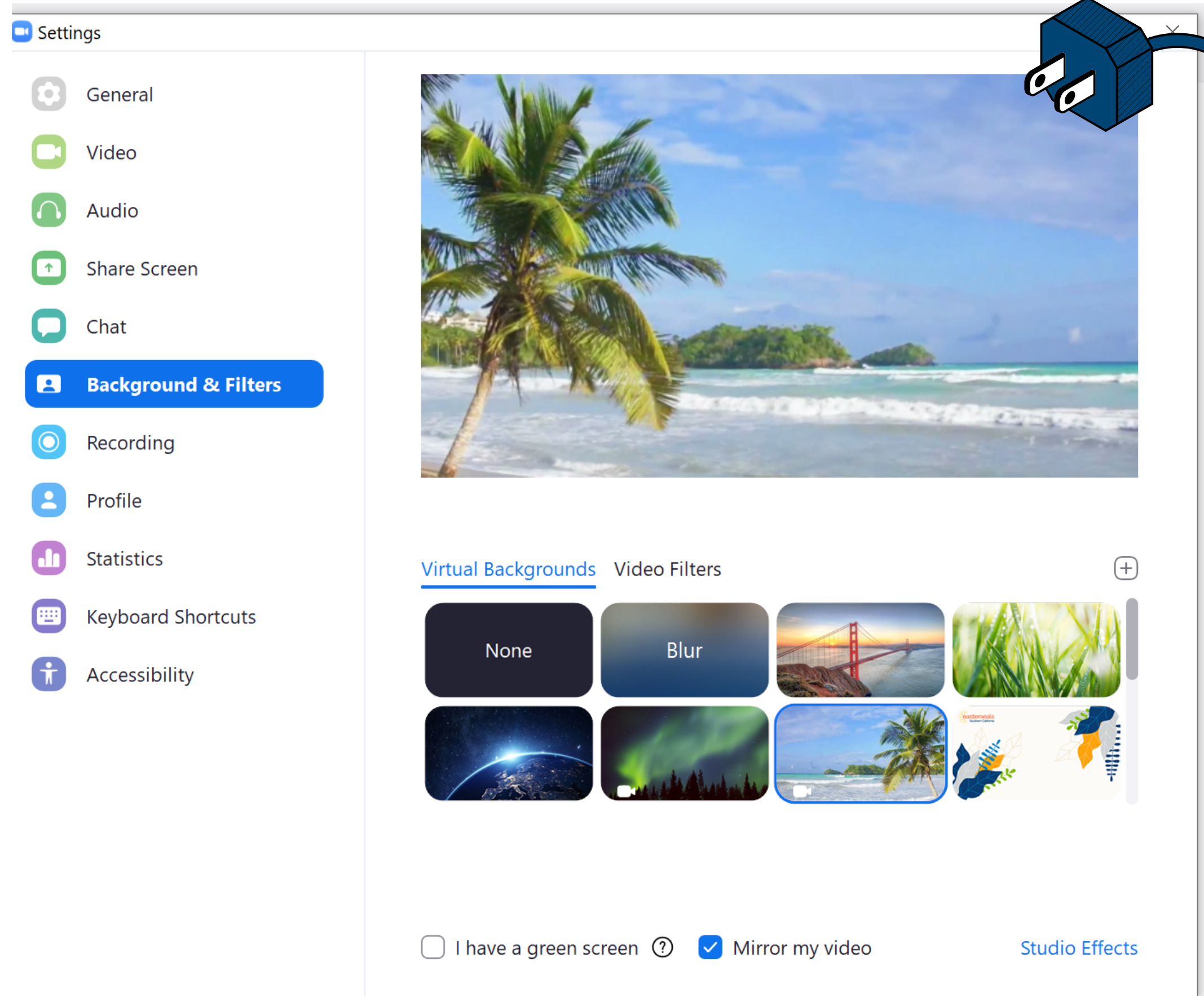

The screenshot shows the Zoom Settings window with the 'Background & Filters' tab selected. The left sidebar lists settings: General, Video, Audio, Share Screen, Chat, Background & Filters (highlighted), Recording, Profile, Statistics, Keyboard Shortcuts, and Accessibility. The main area displays a preview of a tropical beach background with a palm tree. Below the preview are two tabs: 'Virtual Backgrounds' (selected) and 'Video Filters'. Under 'Virtual Backgrounds', there are several options: 'None', 'Blur', a Golden Gate Bridge image, a grass image, a space image, an aurora image, a palm tree image, and a 'Studio Effects' icon. At the bottom, there are checkboxes for 'I have a green screen' (unchecked) and 'Mirror my video' (checked), along with a 'Studio Effects' link.

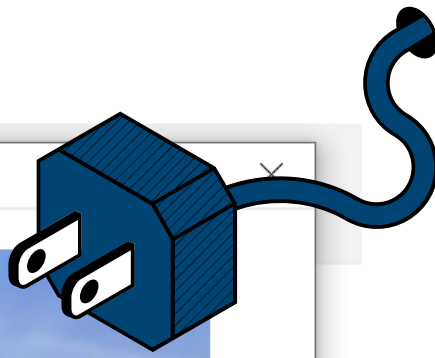

STEP 5

(Optional)

Add your own image by clicking on the plus sign  and uploading a picture or video

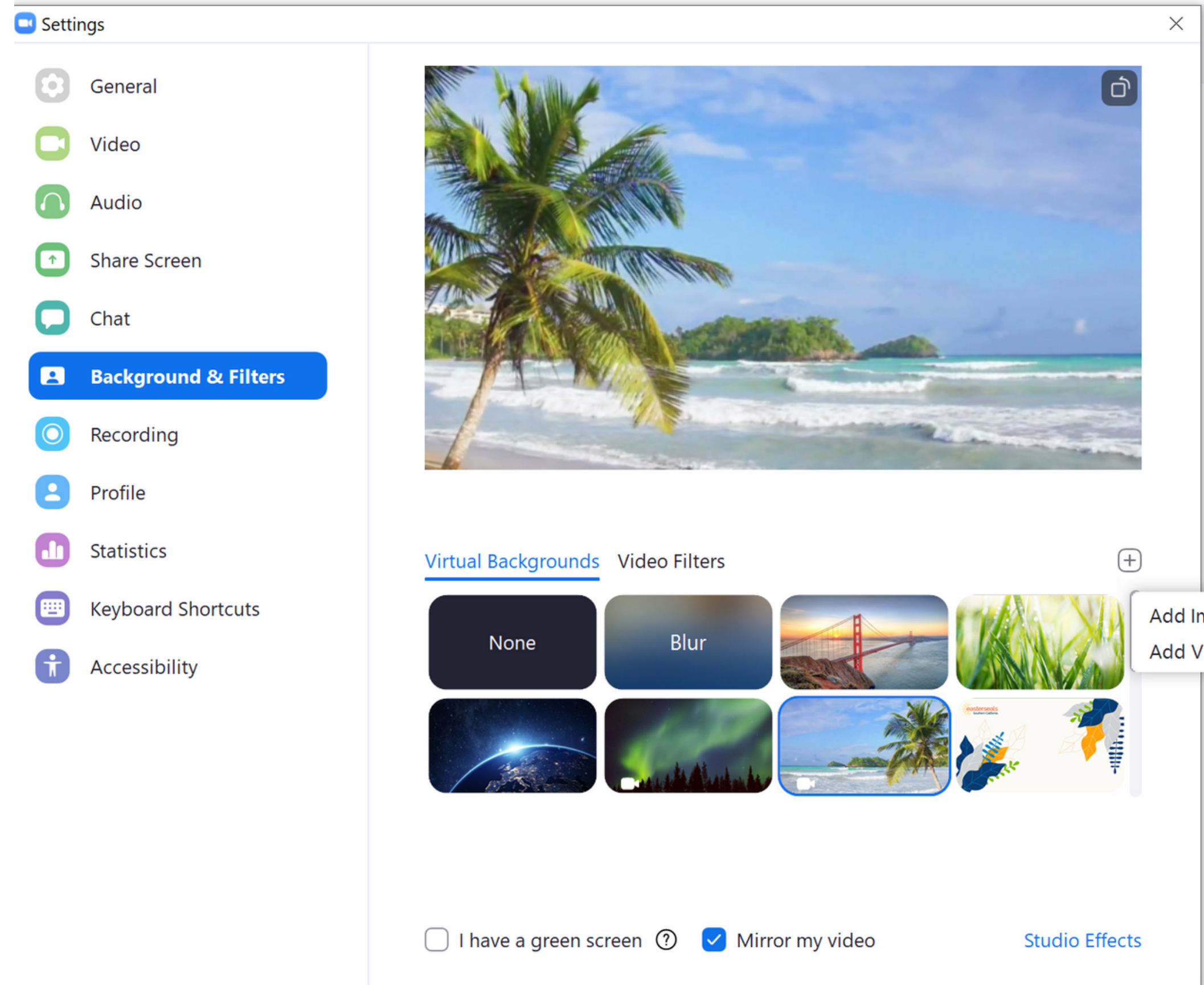

The screenshot shows the Zoom Settings window, specifically the 'Background & Filters' section. On the left, a sidebar lists settings: General, Video, Audio, Share Screen, Chat, Background & Filters (highlighted), Recording, Profile, Statistics, Keyboard Shortcuts, and Accessibility. The main area displays a preview of a tropical beach background. Below the preview, there are two tabs: 'Virtual Backgrounds' (selected) and 'Video Filters'. Under 'Virtual Backgrounds', there are several options: 'None', 'Blur', and a grid of image thumbnails including the Golden Gate Bridge, grass, a globe, and a palm tree. A plus sign icon is next to the thumbnails. At the bottom, there are checkboxes for 'I have a green screen' (unchecked) and 'Mirror my video' (checked), along with a 'Studio Effects' link.

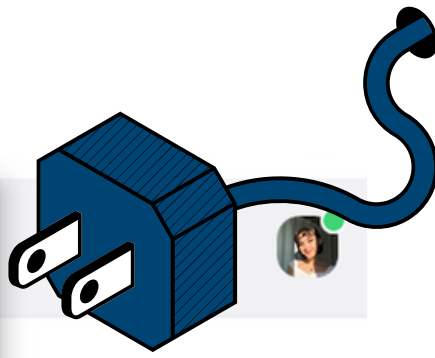

Add Image
Add Video

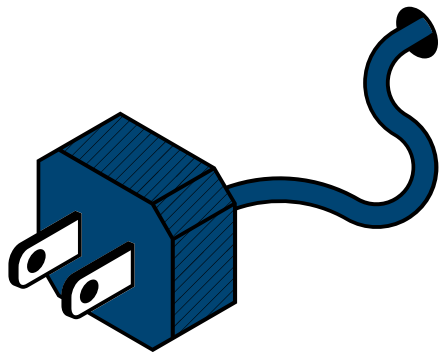

Virtual Backgrounds

Video Filters

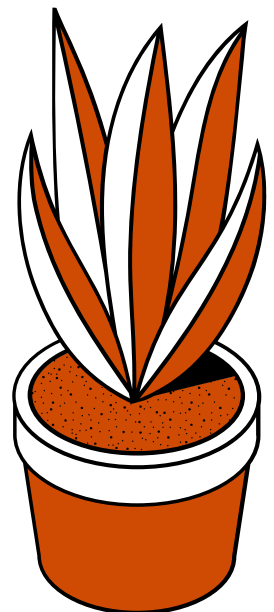
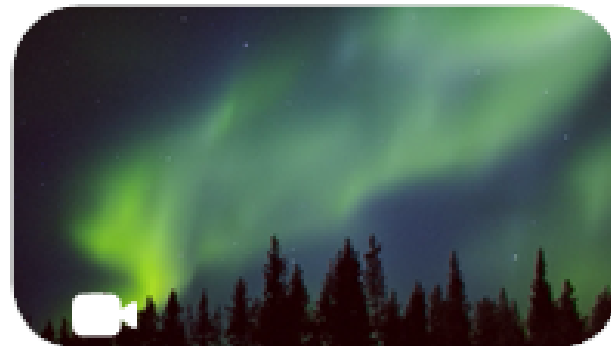
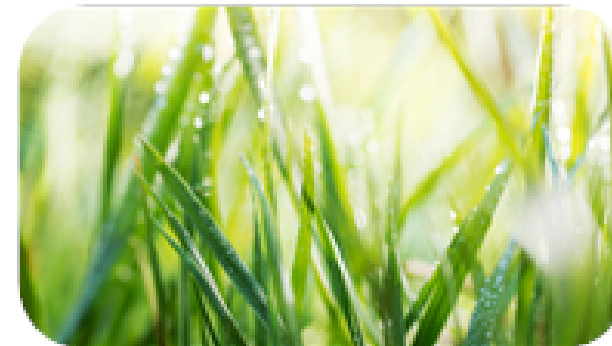
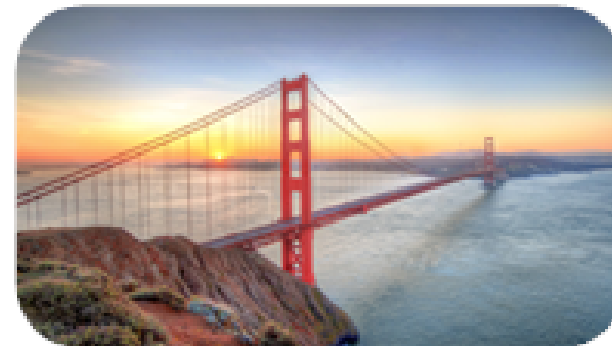
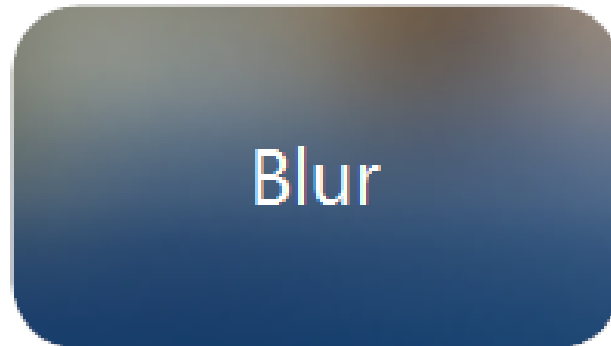
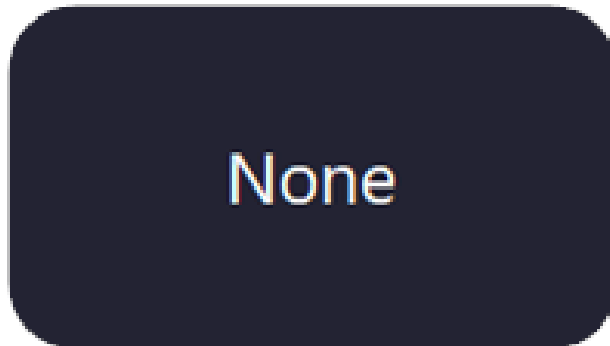

I have a green screen 

Mirror my video

Studio Effects

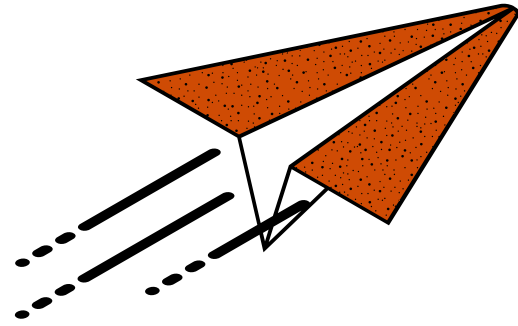

LET'S TRY IT

CHANGING YOUR VIRTUAL BACKGROUND ON IPAD OR MOBILE DEVICE

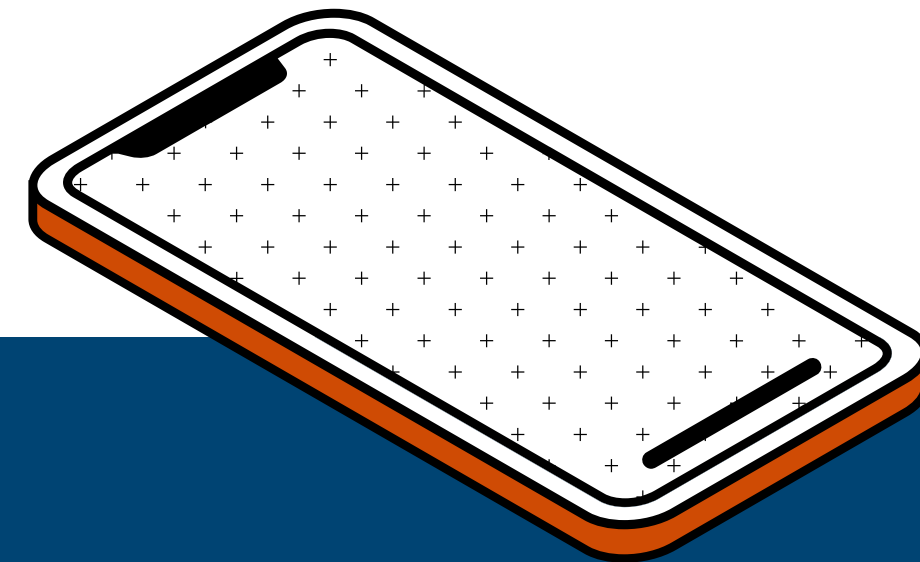
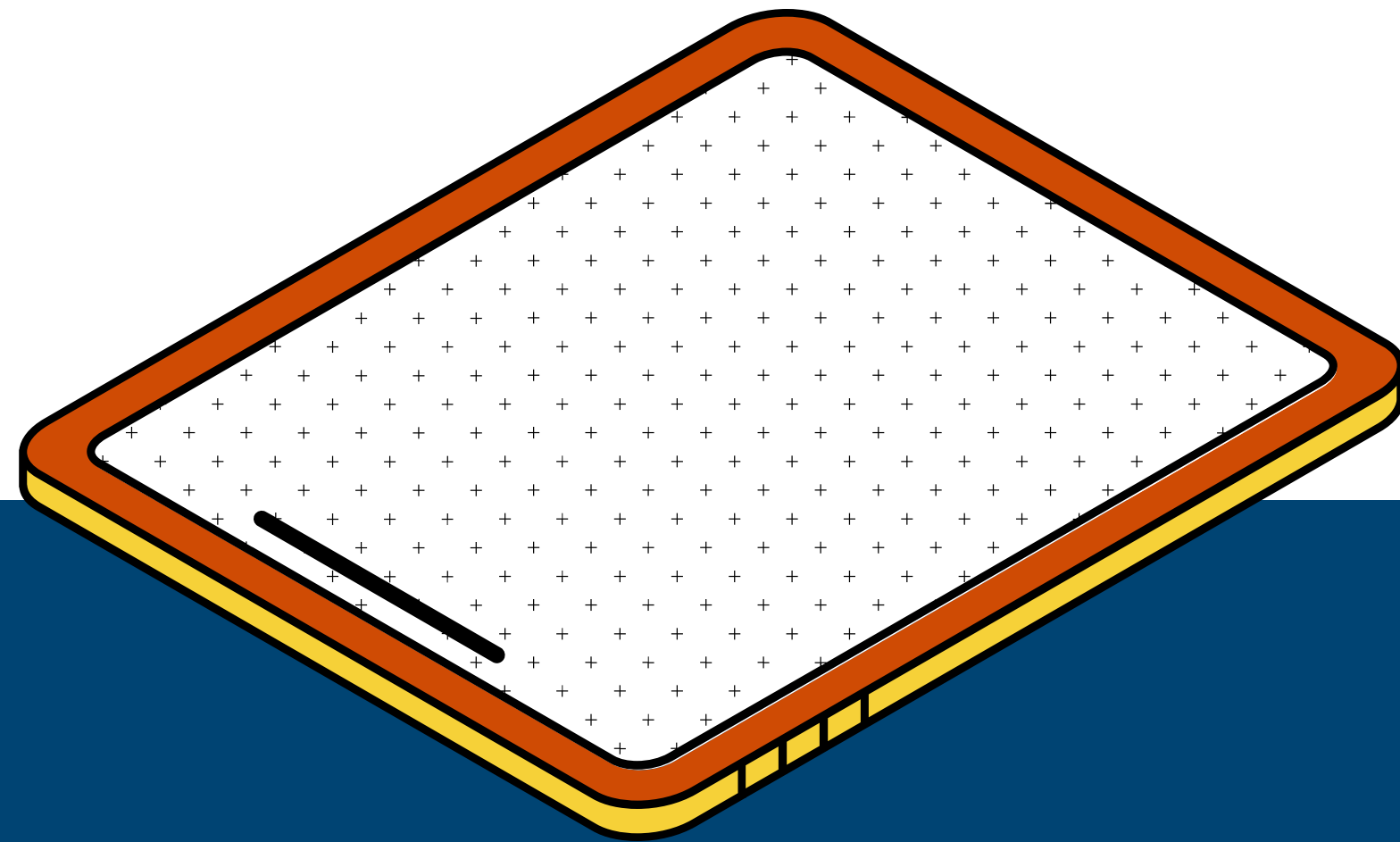

STEP 1

Sign in to Zoom

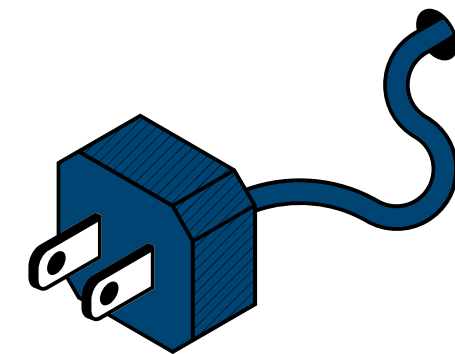

STEP 1

Sign in to Zoom

STEP 2

While in a zoom meeting,
tap "More" in your controls

- located in the TOP RIGHT corner on iPad
- located in the BOTTOM RIGHT corner on mobile

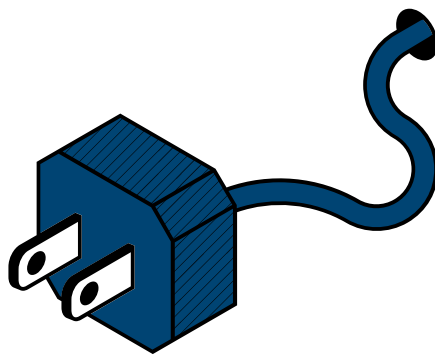
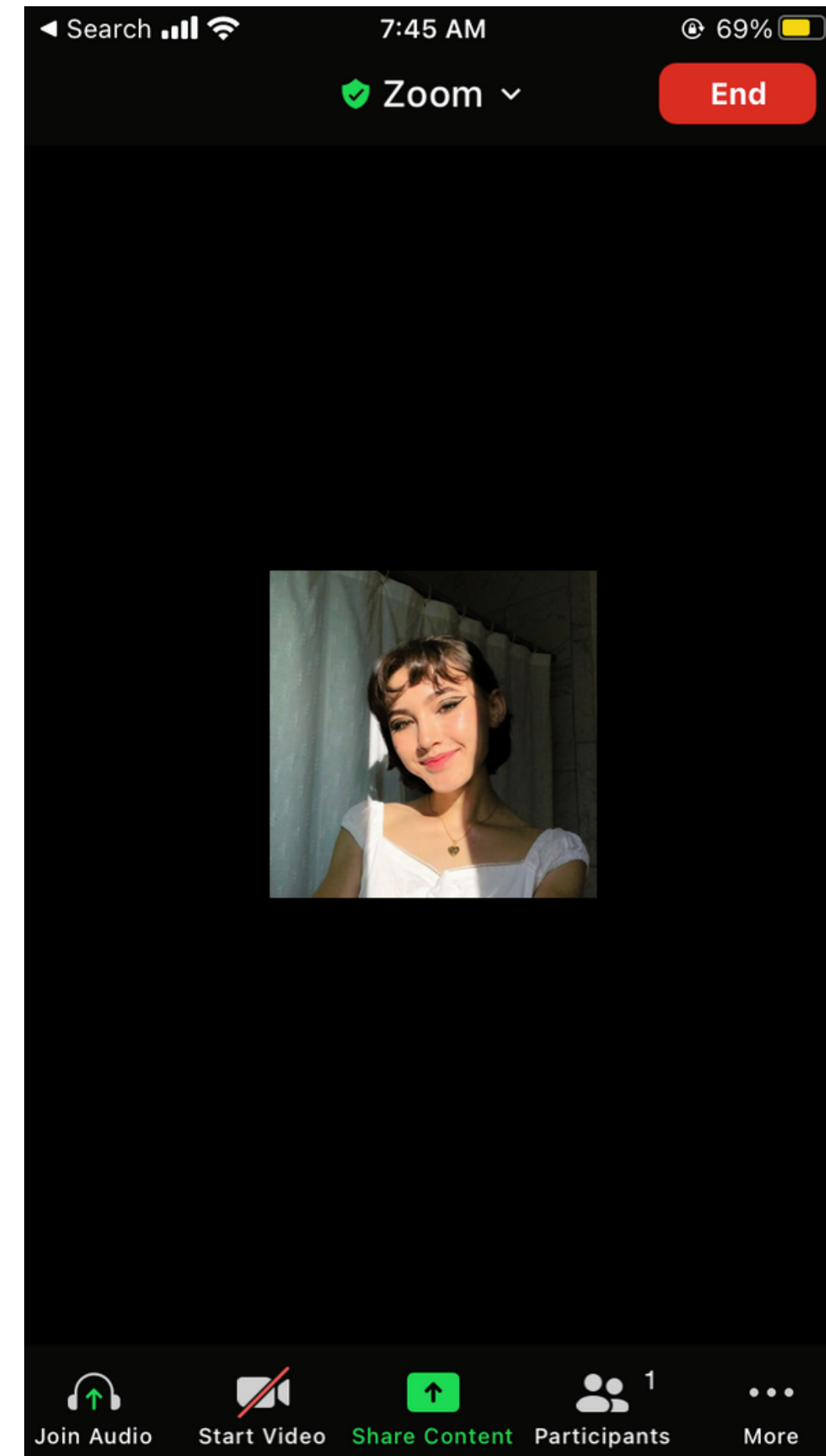

STEP 3

Tap "Background & Filters"

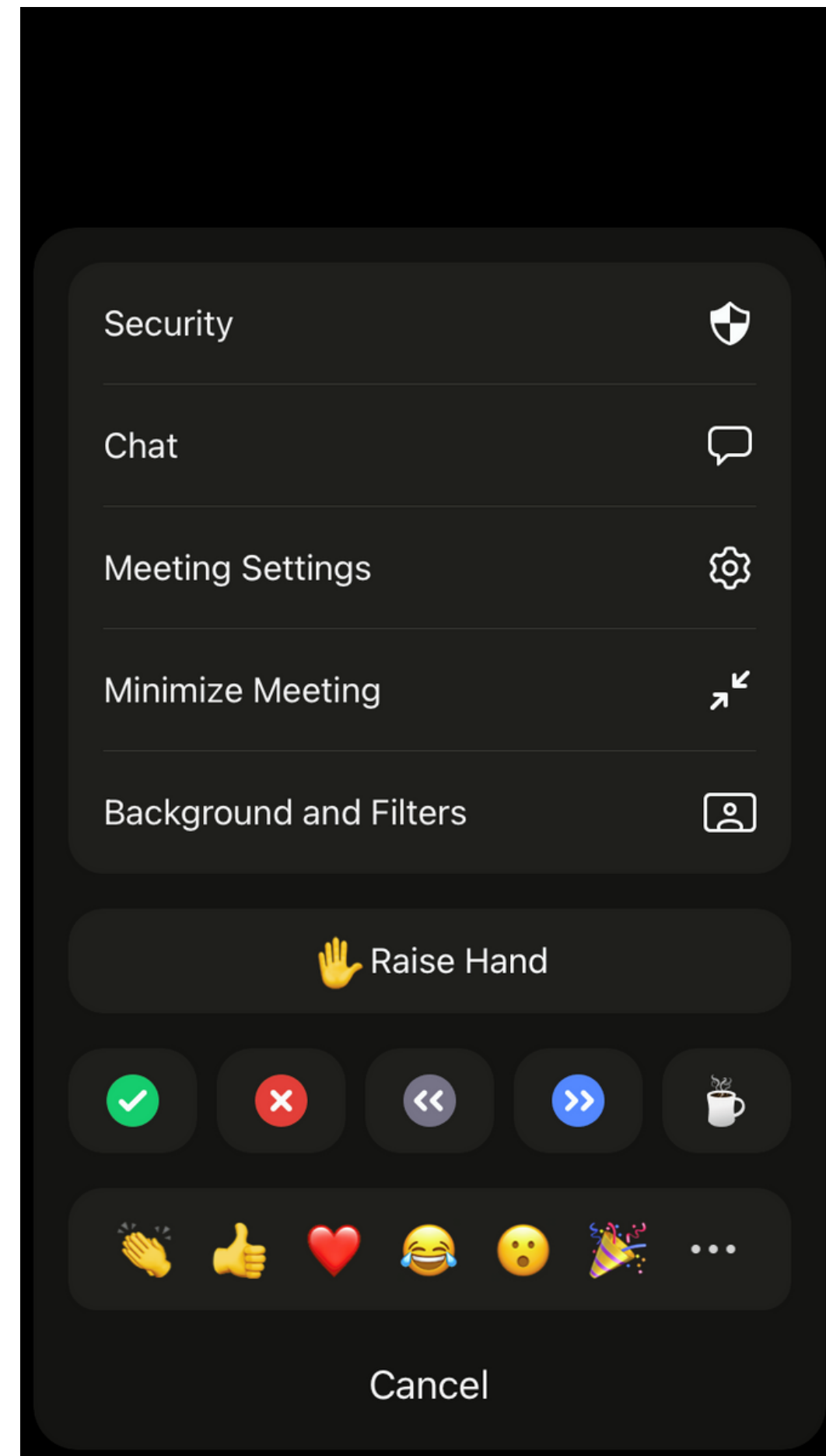
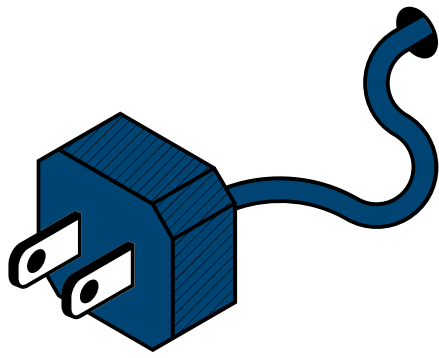

STEP 3

Tap "Background & Filters"

STEP 4

Tap on the background that you would like to apply

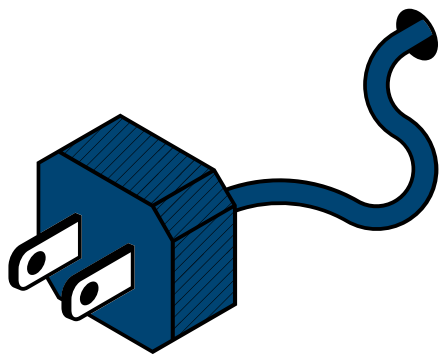
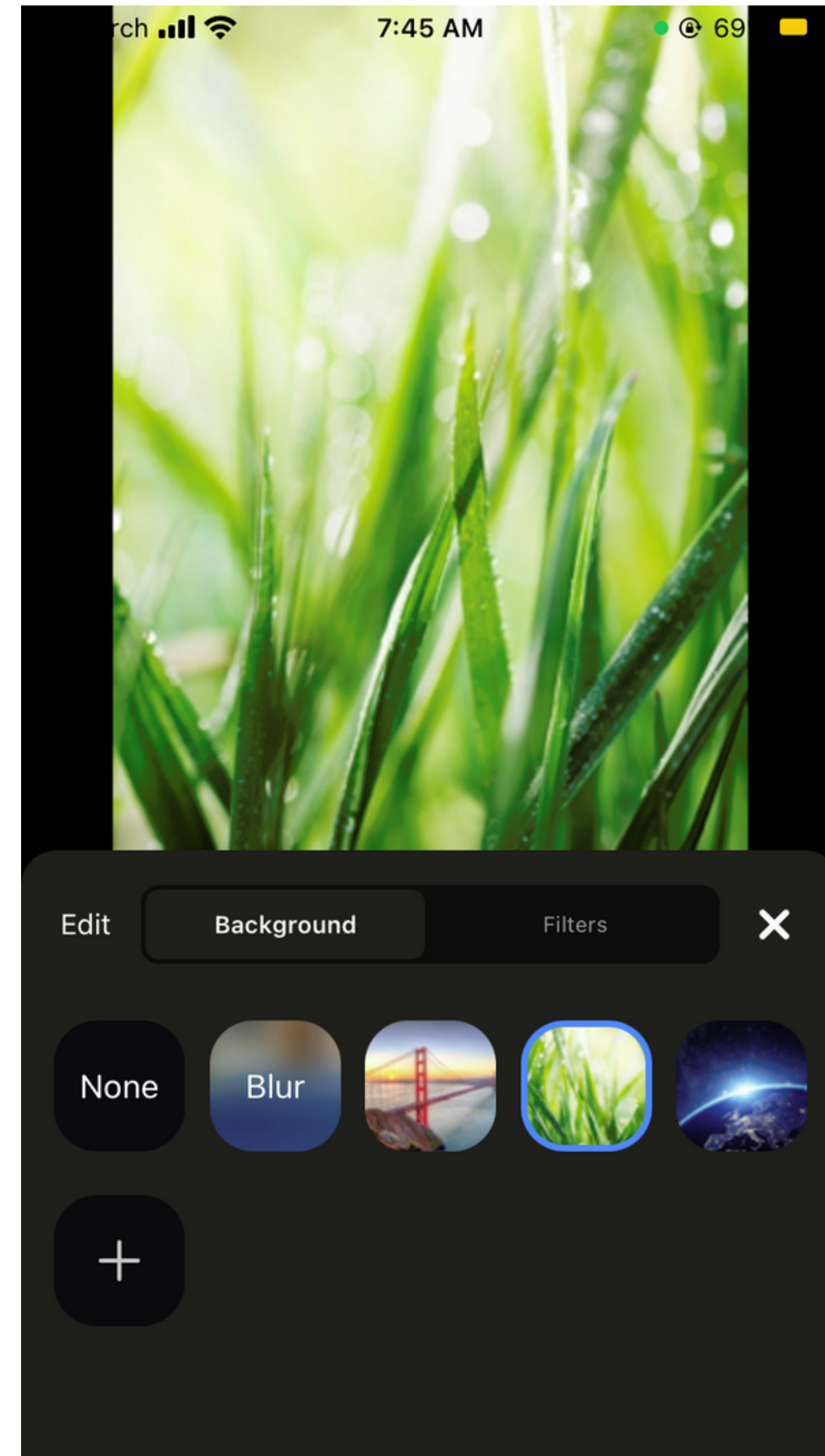

STEP 5

(Optional)

Add your own image by clicking on the plus sign  and uploading a picture or video

STEP 6

Tap "x" to return to your meeting

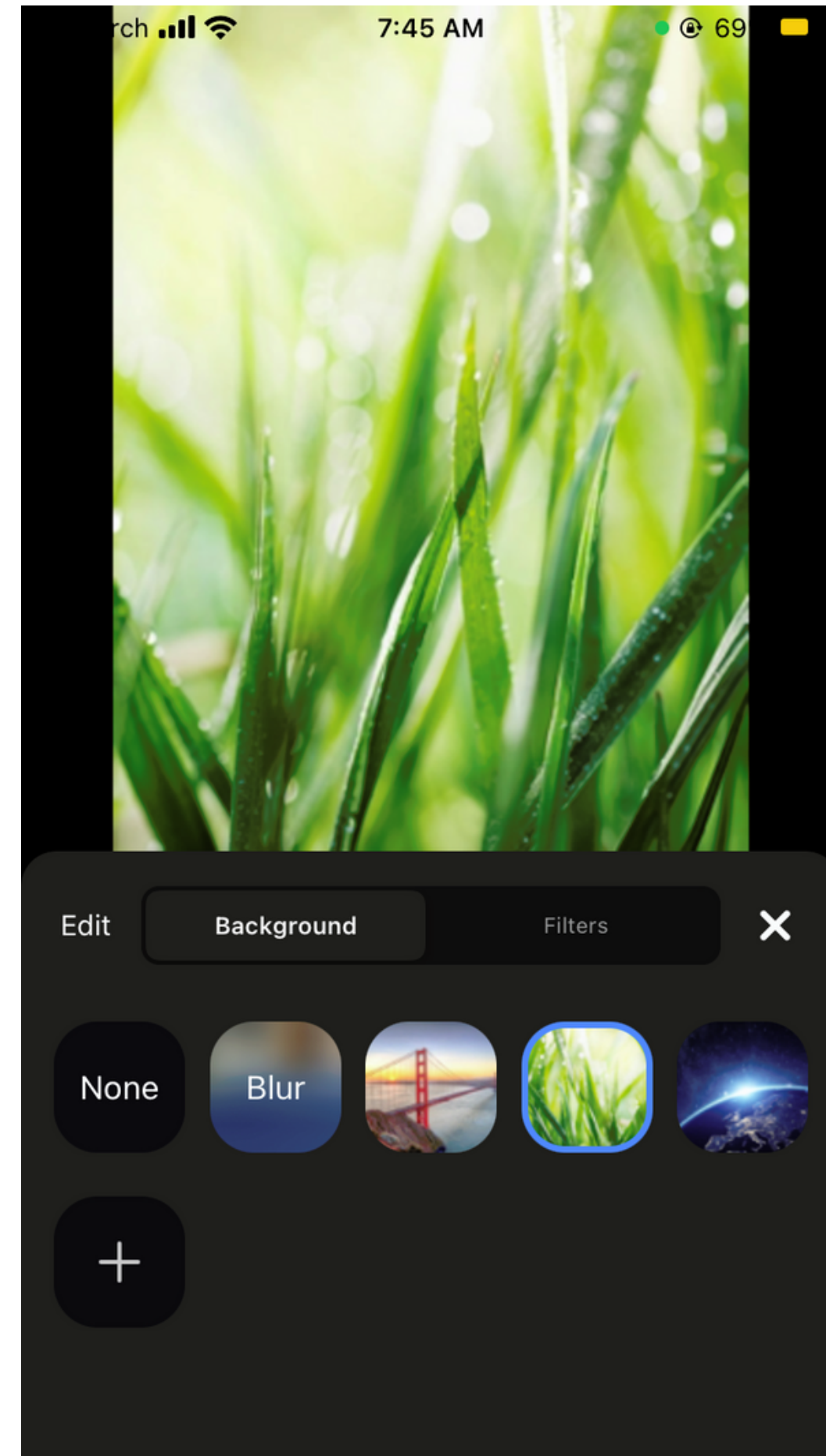

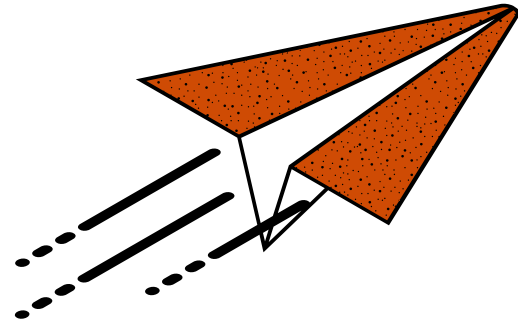

LET'S TRY IT

USING VIDEO FILTERS ON DESKTOP



STEP 1

Sign in to Zoom

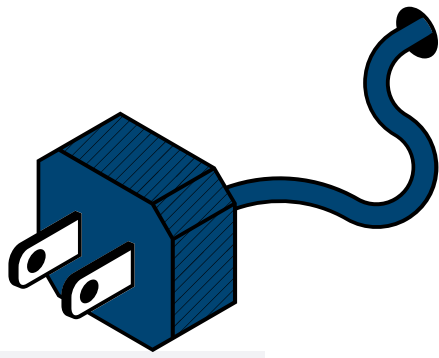

STEP 2

Click on your profile picture located on in the top right of your window

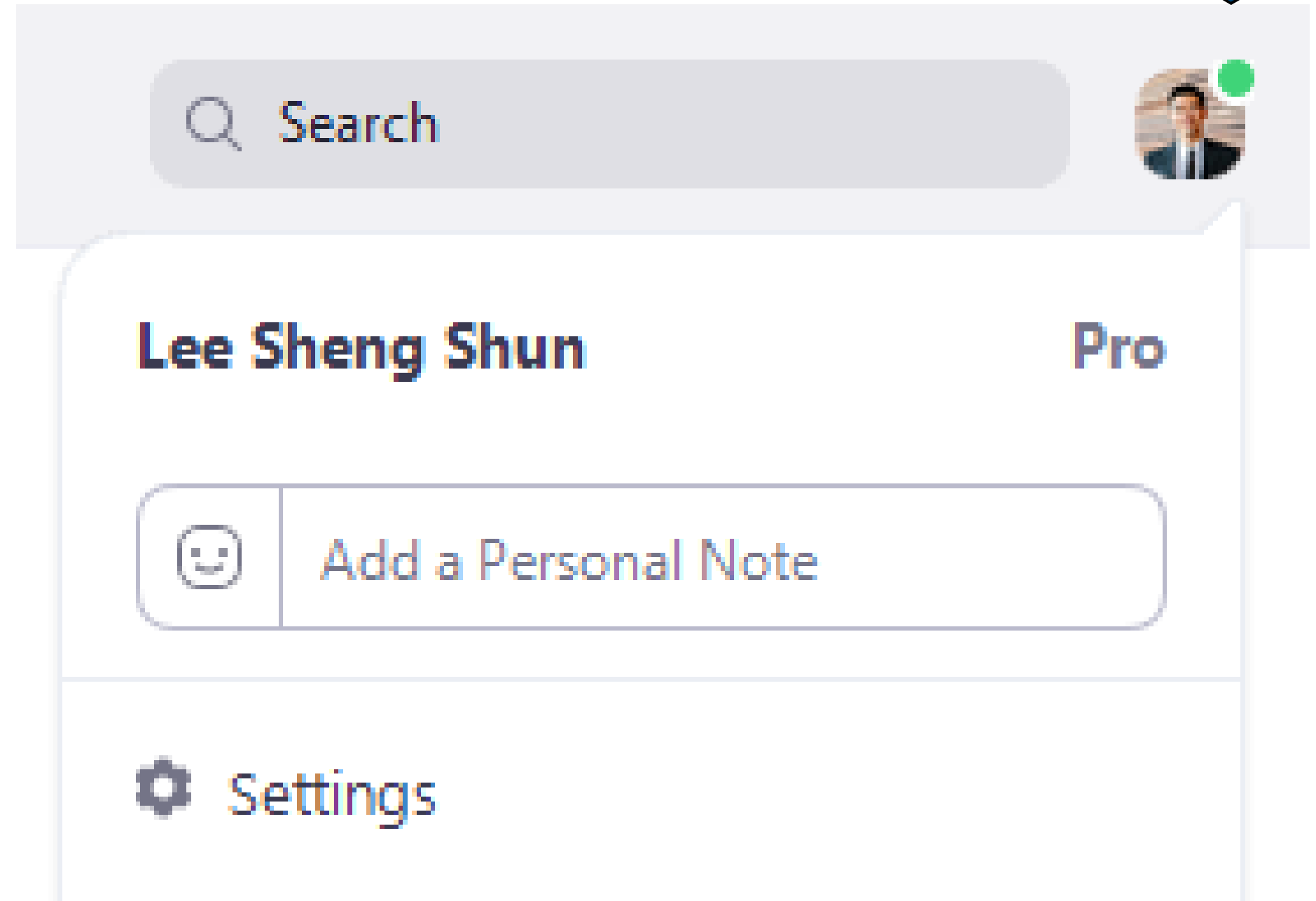

STEP 3

In the drop down menu, click "  settings "

STEP 4

Select "  Background & Filters "

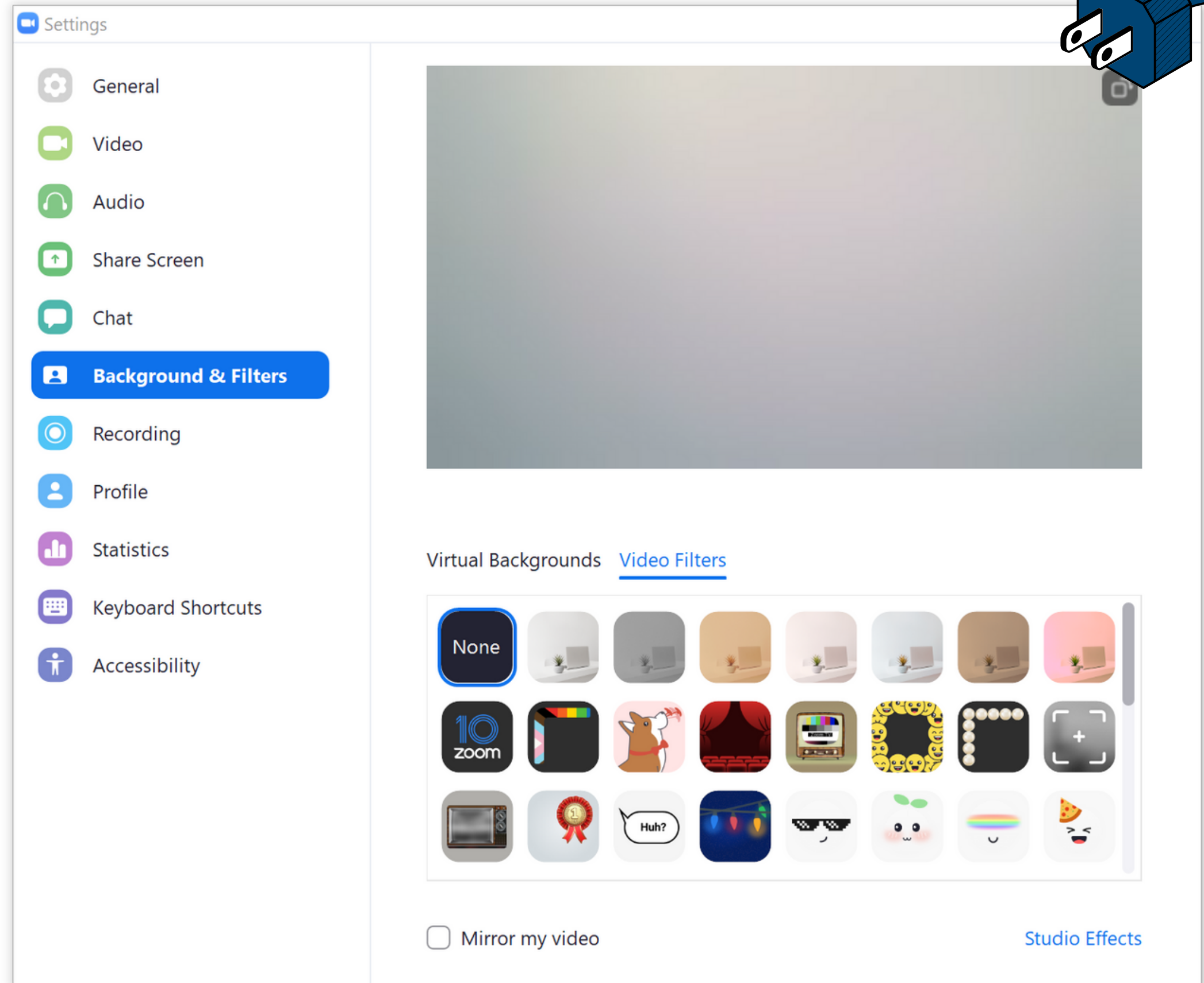

The screenshot shows the Zoom Settings application window. The left sidebar contains a list of settings categories: General, Video, Audio, Share Screen, Chat, **Background & Filters** (highlighted in blue), Recording, Profile, Statistics, Keyboard Shortcuts, and Accessibility. The main content area is titled "Background & Filters" and features a large grey preview window at the top. Below the preview, there are two tabs: "Virtual Backgrounds" and "Video Filters", with "Video Filters" currently selected. A grid of 24 filter icons is displayed, including "None", "10 zoom", a dog, a theater, a TV, a smiley face border, a plus sign, a TV, a gold medal, a speech bubble saying "Huh?", string lights, sunglasses, a cat face, a rainbow, and a pizza. At the bottom left, there is a checkbox labeled "Mirror my video" which is currently unchecked. At the bottom right, there is a link for "Studio Effects". A blue power plug icon is positioned in the top right corner of the overall image.

STEP 4

Select "  Background & Filters "

STEP 5

Click on " Video Filters "

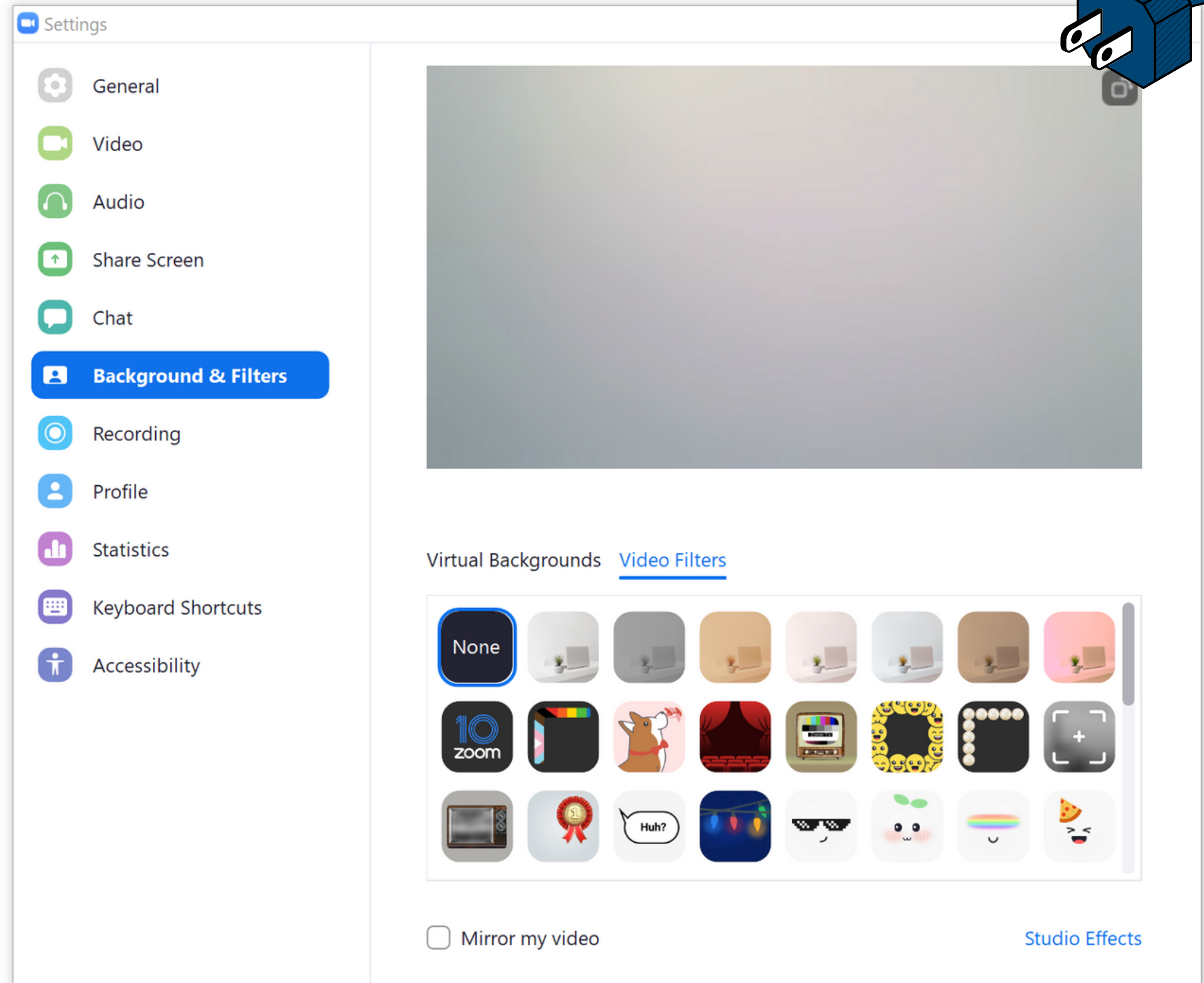

The screenshot shows the Zoom Settings window with the 'Background & Filters' tab selected. The left sidebar lists various settings categories, with 'Background & Filters' highlighted in blue. The main content area shows a large grey preview window at the top. Below it, there are two tabs: 'Virtual Backgrounds' and 'Video Filters', with 'Video Filters' being the active tab. A grid of 24 filter icons is displayed, including 'None', '10 zoom', and various cartoon and holiday-themed filters. At the bottom, there is a checkbox for 'Mirror my video' and a link for 'Studio Effects'. A blue power plug icon is positioned in the top right corner of the screenshot.

Settings

- General
- Video
- Audio
- Share Screen
- Chat
- Background & Filters**
- Recording
- Profile
- Statistics
- Keyboard Shortcuts
- Accessibility

Virtual Backgrounds [Video Filters](#)

None, 10 zoom, [various filter icons]

Mirror my video [Studio Effects](#)

STEP 4

Select "  Background & Filters "

STEP 5

Click on " Video Filters "

STEP 6

Choose a filter that you would like to apply to your video

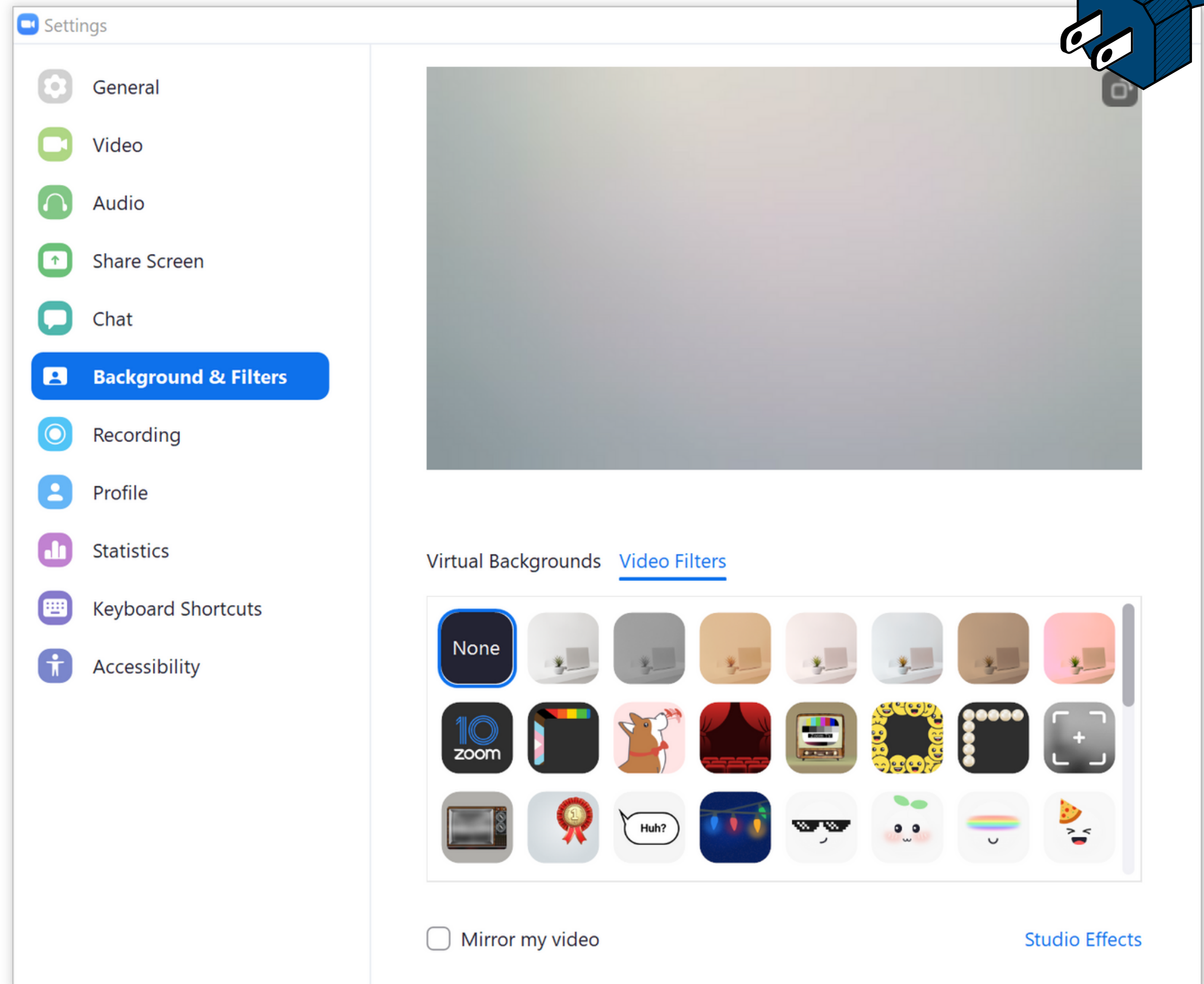

USING VIDEO FILTERS ON DESKTOP

while in a meeting



STEP 1

While in a meeting,
click on the small
arrow next to the
camera icon

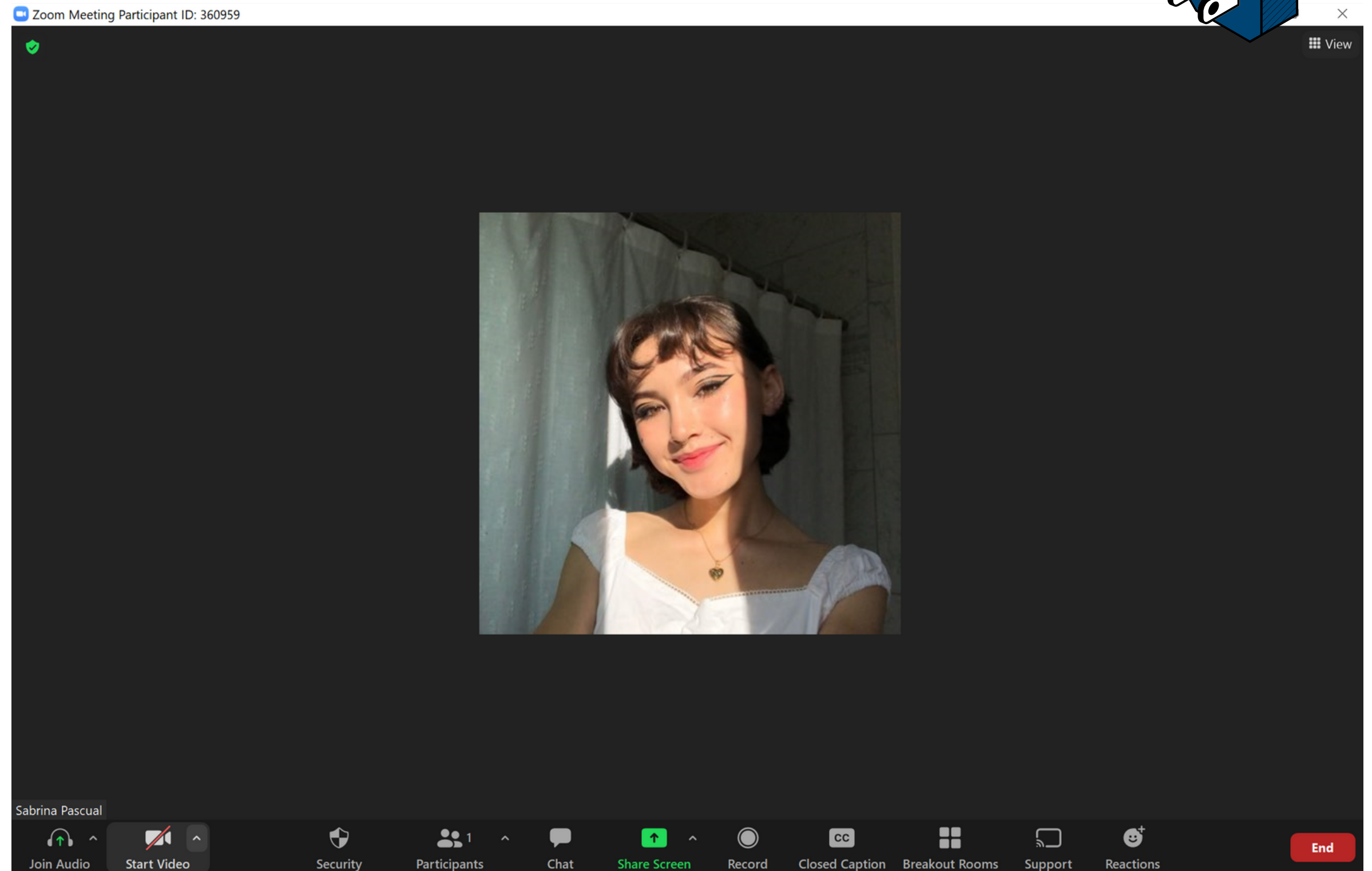
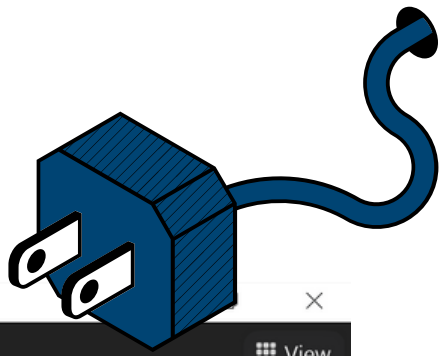

STEP 2

Click on " Choose Video Filter... "

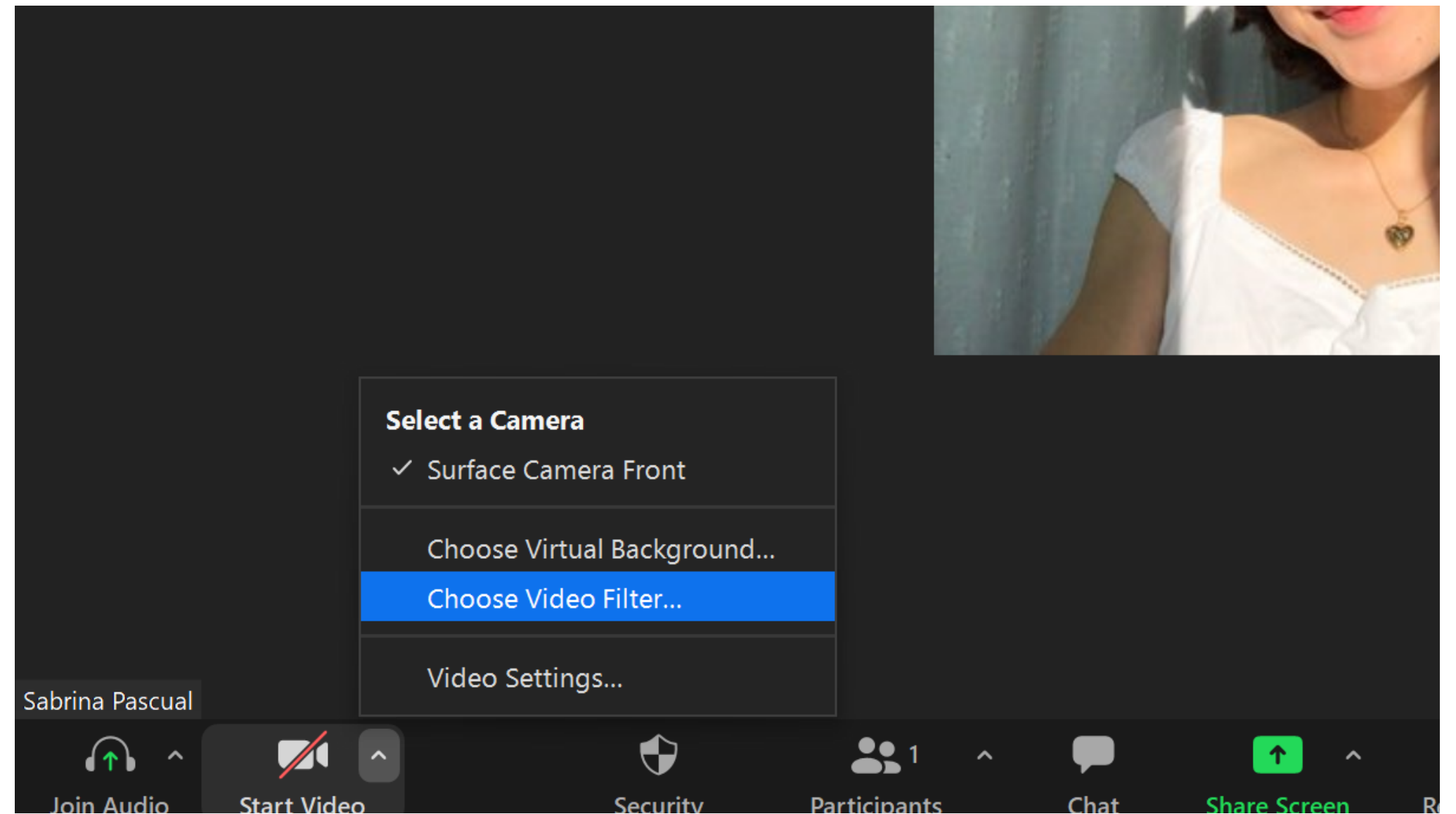
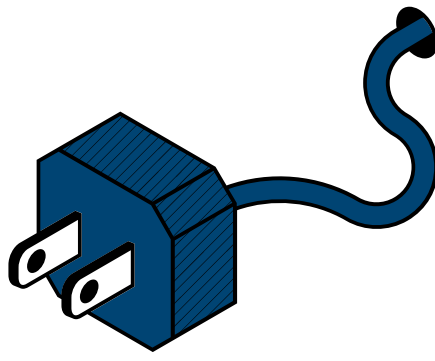

STEP 6

Choose a filter that you would like to apply to your video

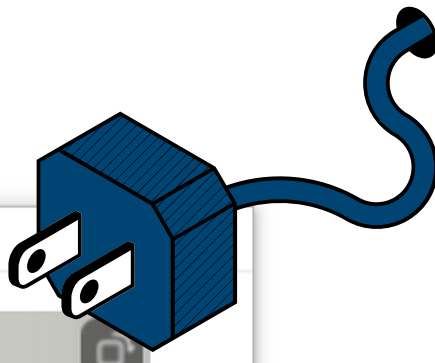

Settings

- General
- Video
- Audio
- Share Screen
- Chat
- Background & Filters**
- Recording
- Profile
- Statistics
- Keyboard Shortcuts
- Accessibility

Virtual Backgrounds [Video Filters](#)

None, 10 zoom, Cute Cat, Theater, TV, Emojis, Party, Huh?, Sunglasses, Smiley Face, Rainbow, Pizza

Mirror my video [Studio Effects](#)

USING VIDEO FILTERS ON IPAD OR MOBILE DEVICE

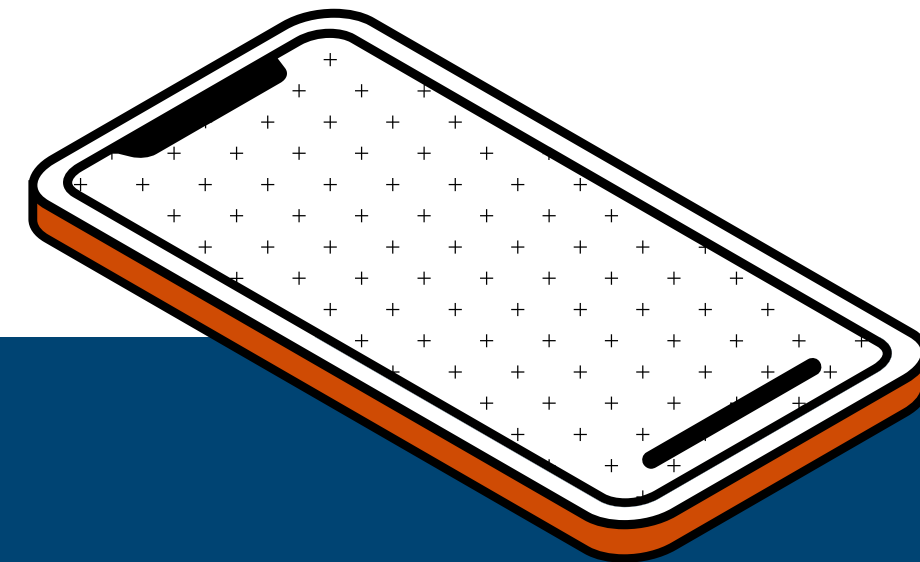
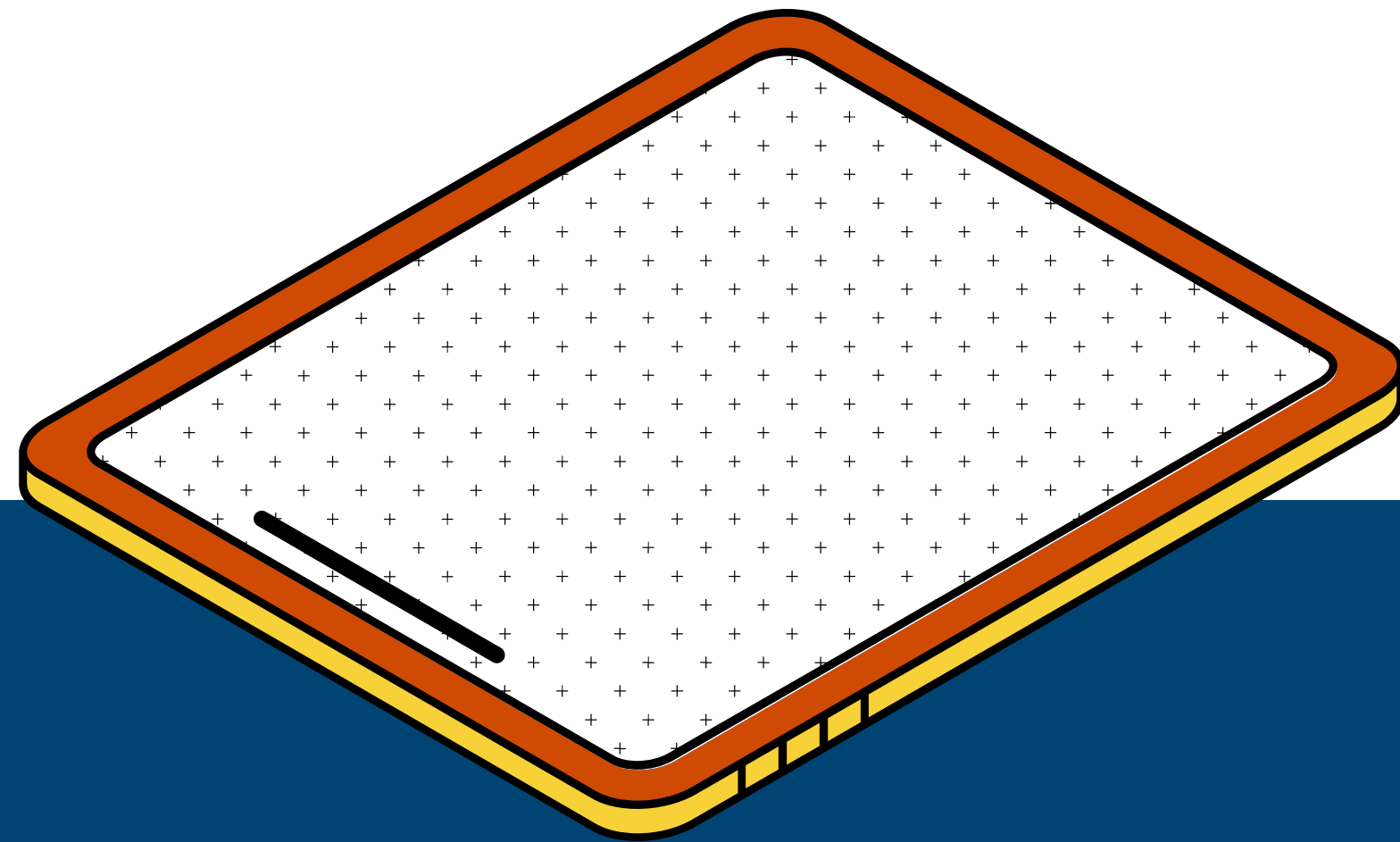

STEP 1

Sign in to Zoom

STEP 2

While in a zoom meeting,
tap "More" in your controls

- located in the TOP RIGHT corner on iPad
- located in the BOTTOM RIGHT corner on mobile

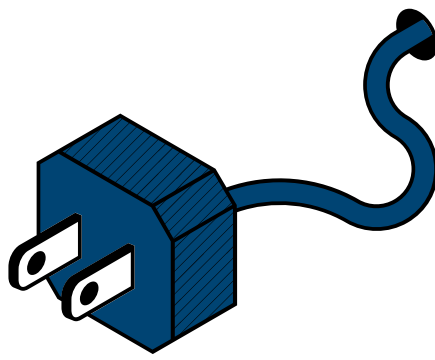
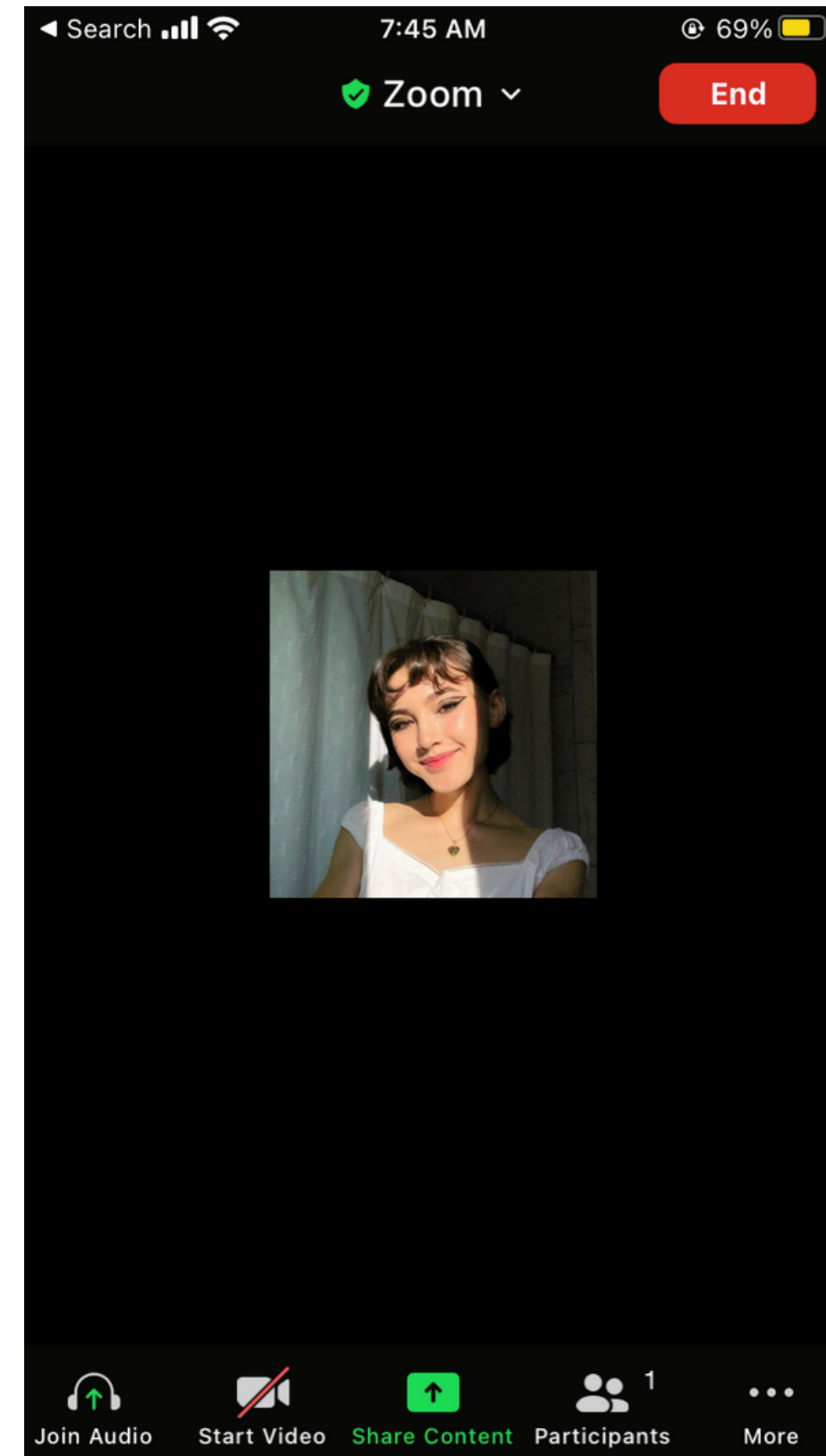

STEP 3

Tap "Background & Filters"

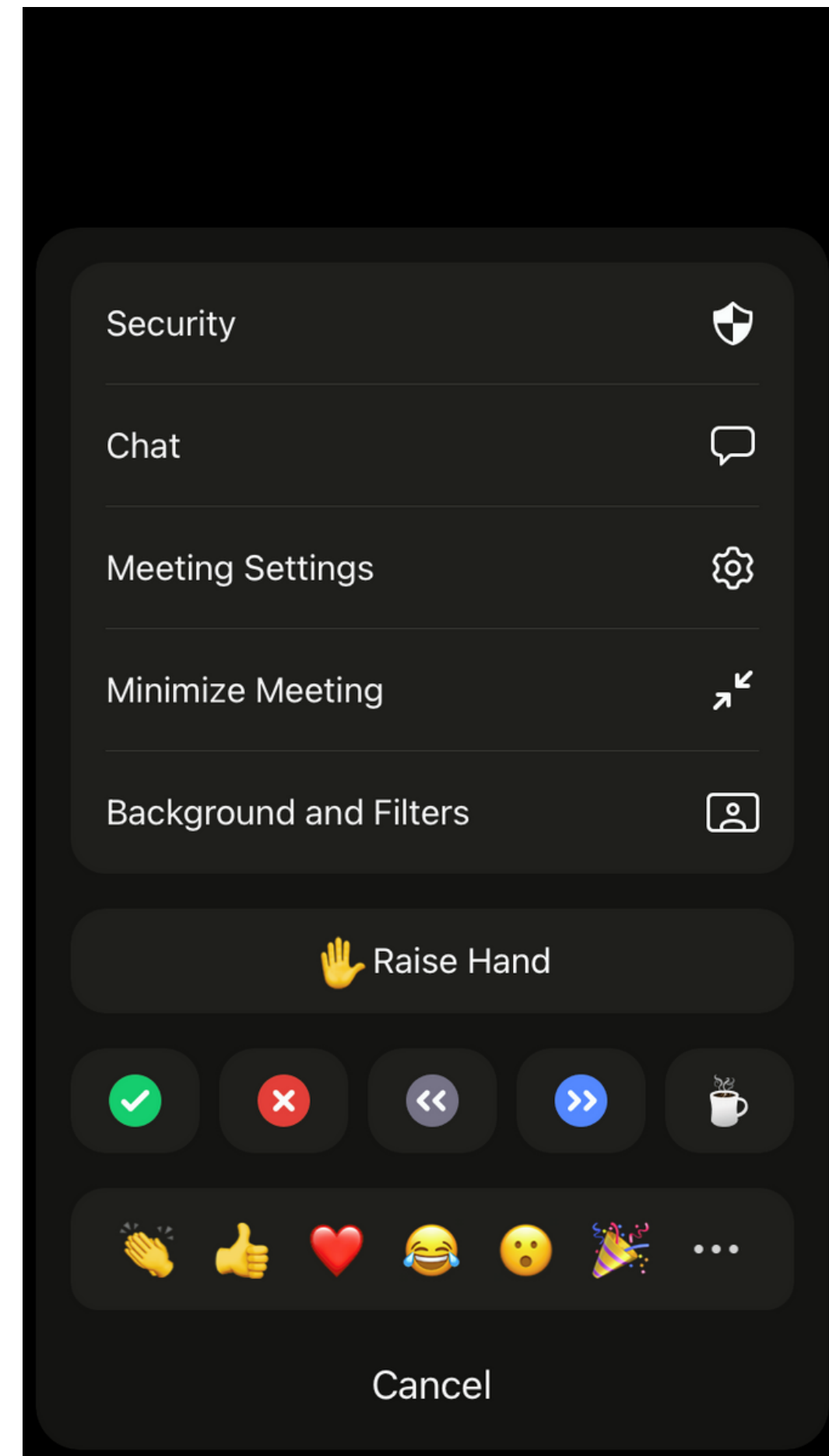
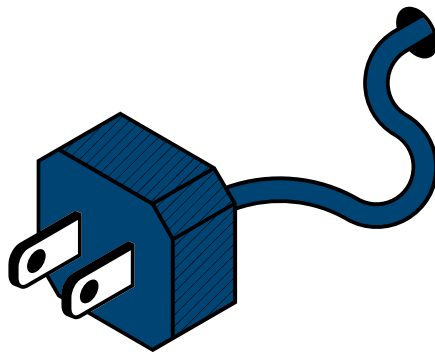

STEP 3

Tap "Background & Filters"

STEP 4

Tap on "Filters"

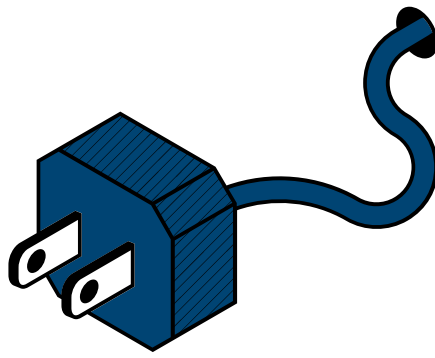
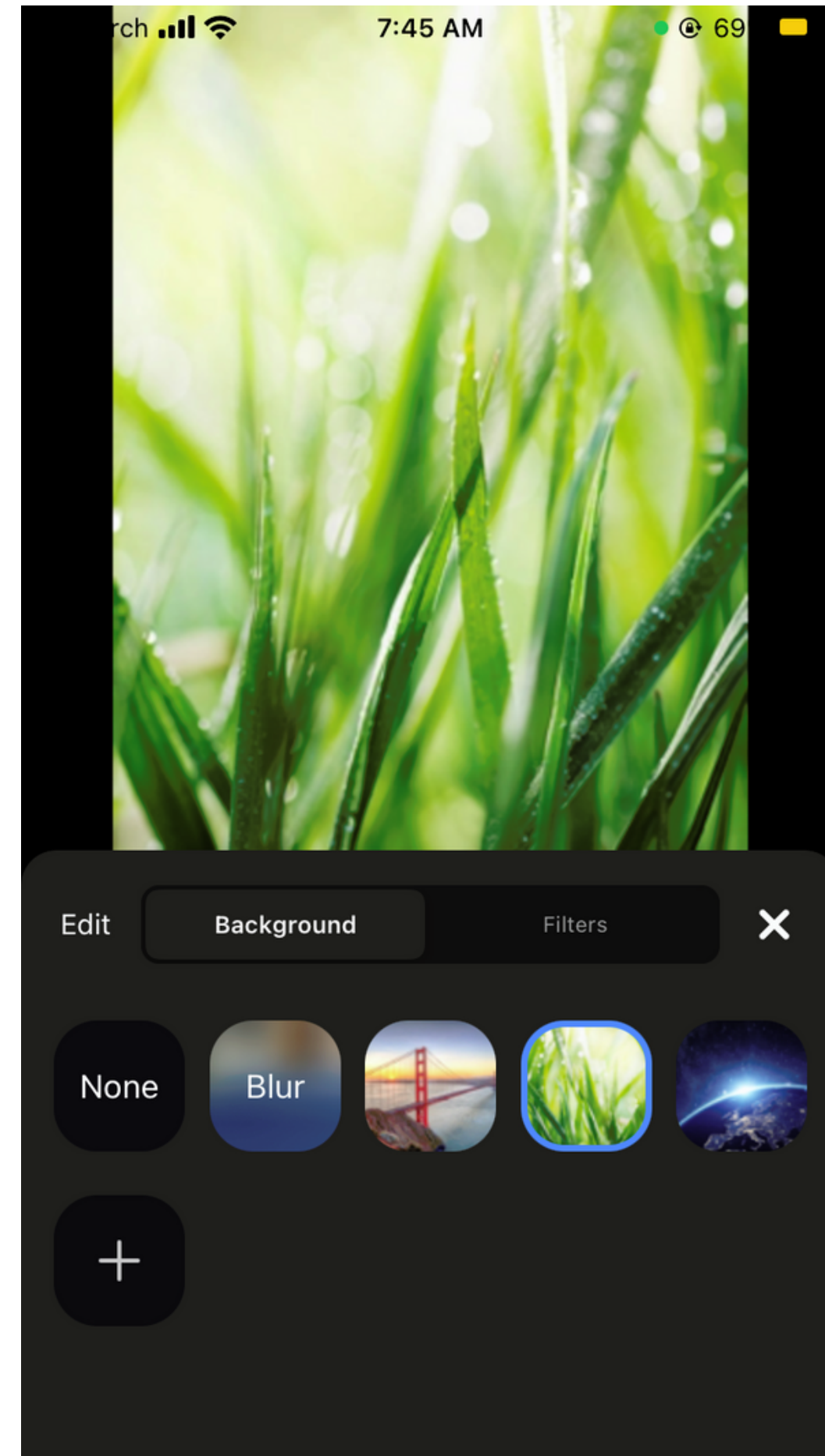

STEP 3

Tap "Background & Filters"

STEP 4

Tap on "Filters"

STEP 5

Tap on the video filter that you would like to apply

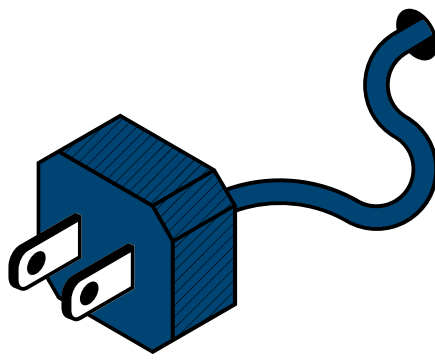
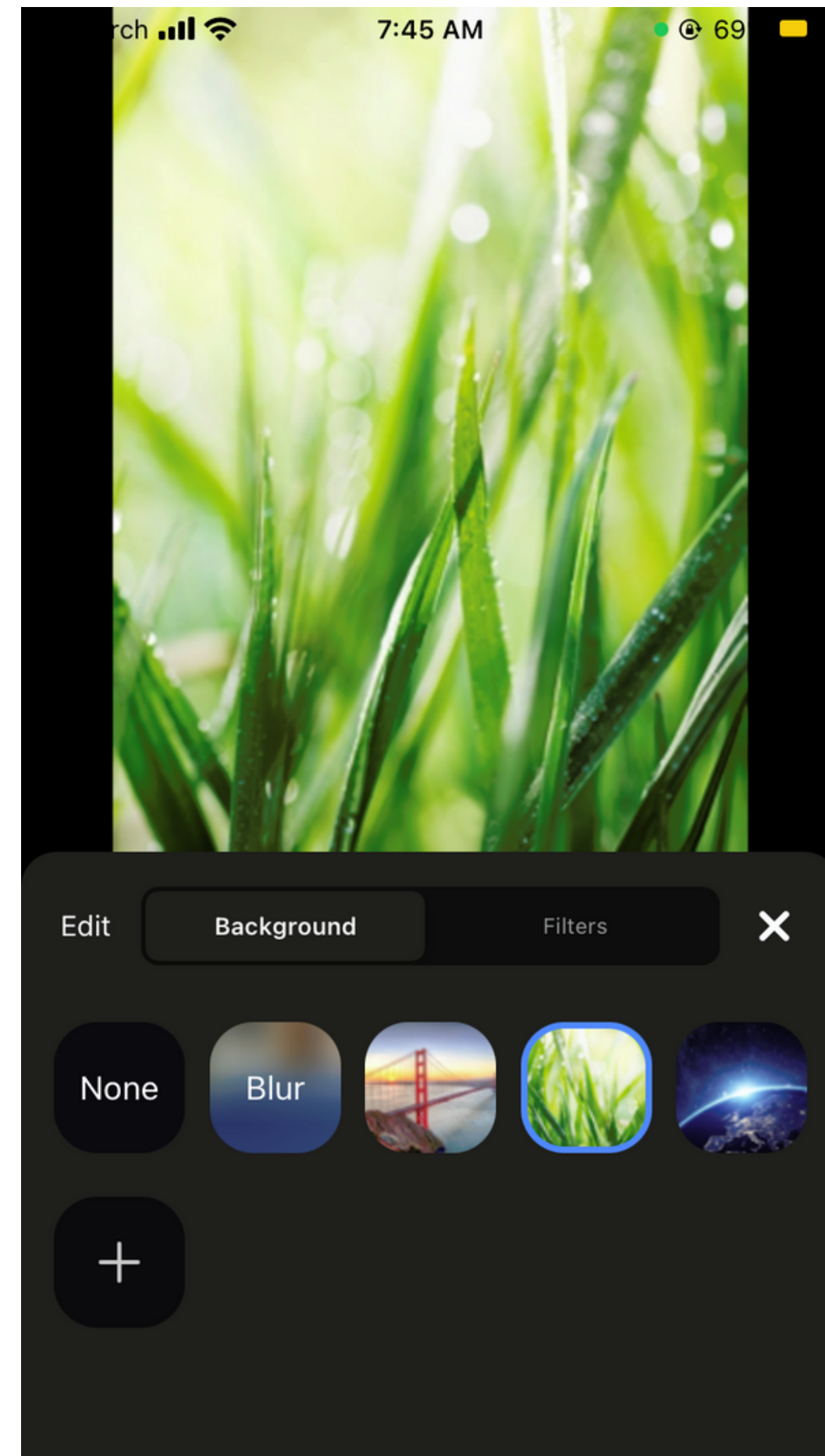

STEP 3

Tap " Background & Filters "

STEP 4

Tap on the background that you would like to apply OR tap + to upload your own

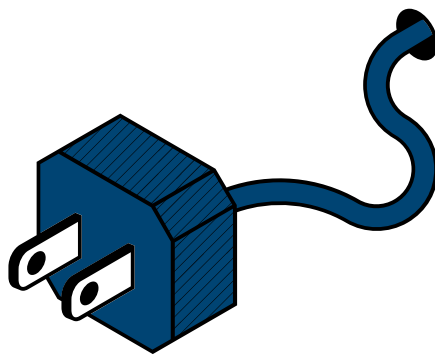
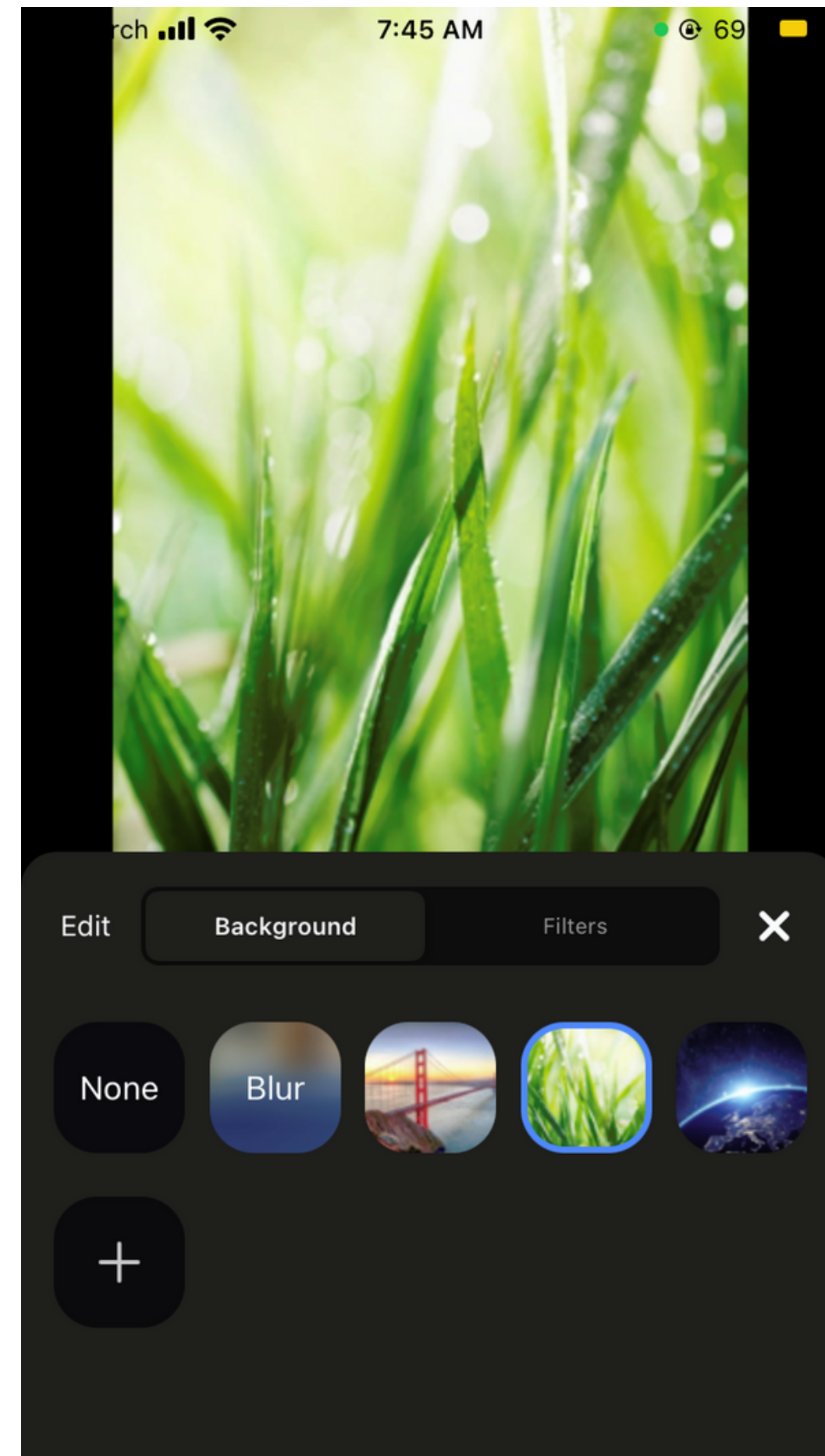

STEP 5

(Optional)

Add your own image by clicking on the plus sign  and uploading a picture or video

STEP 6

Tap "x" to return to your meeting

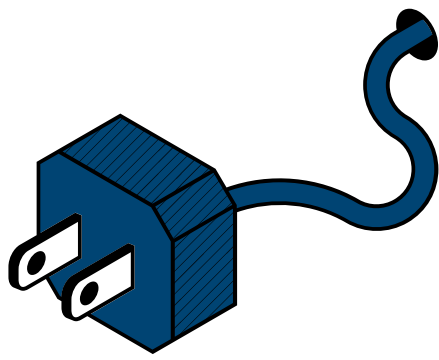
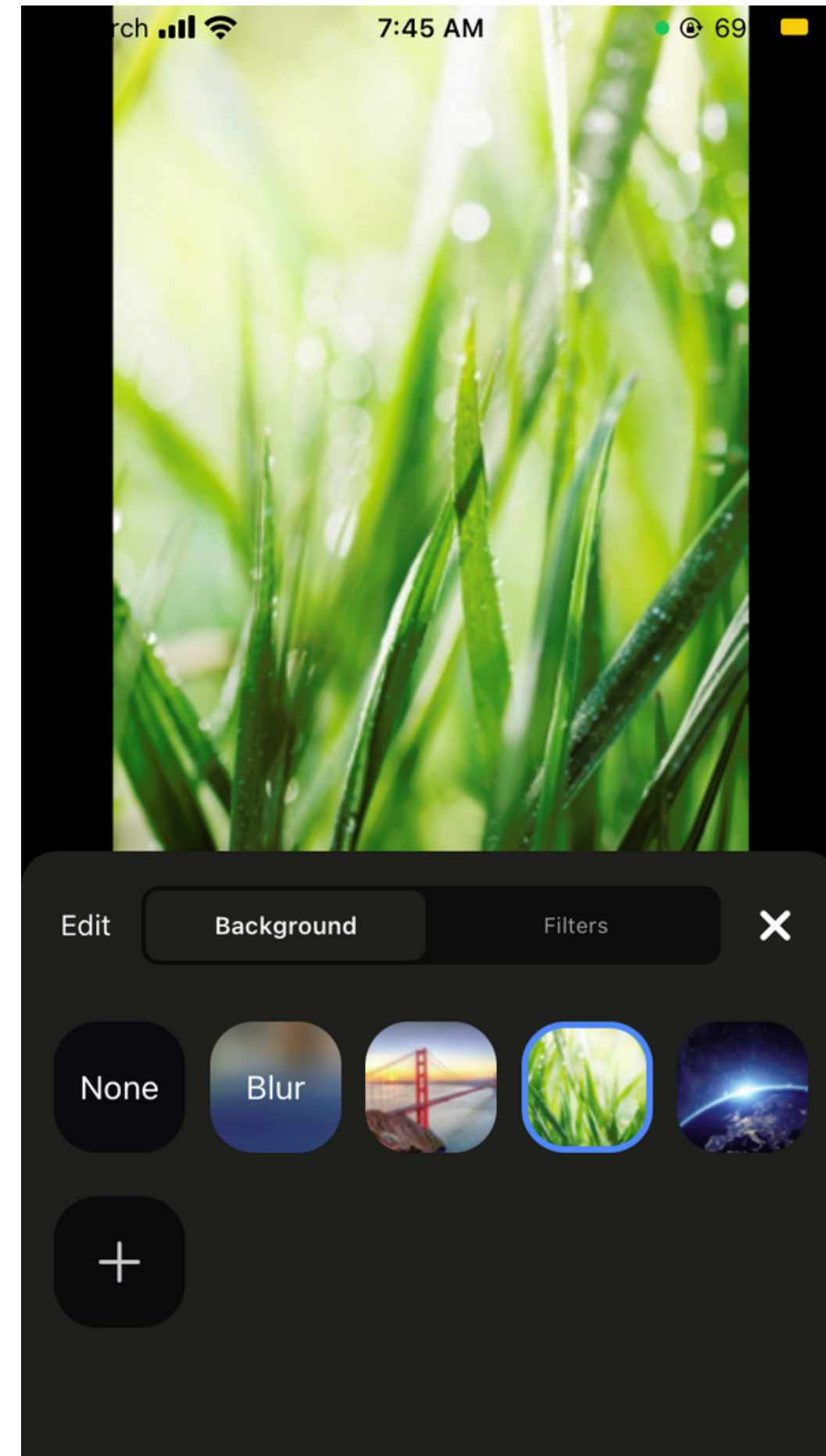

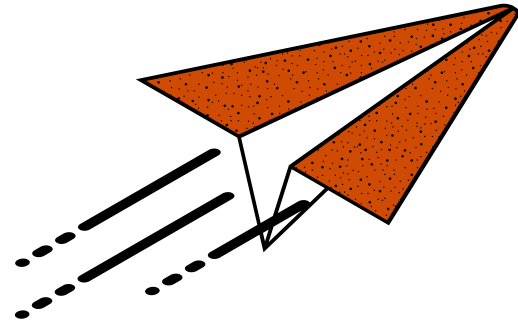

LET'S TRY IT



THANKS!

Visit esscvirtualcommunity.com for more workshops or contact sabrina.pascual@essc.org

